

Power Relay K (Open – Sealed)

- Limiting continuous current 45A
- Wide voltage range
- 24VDC coil versions available
- For high current version refer to Power Relay K-S

Typical applications

ABS control, blower fans, car alarm, cooling fan, engine control, fuel pump, hazard warning signal, heated front screen, heated rear screen, ignition, lamps front/rear/fog light, interior lights, main switch/supply relay, seat control, seatbelt pretensioner, sun roof, turn signal, valves, window lifter, wiper control.

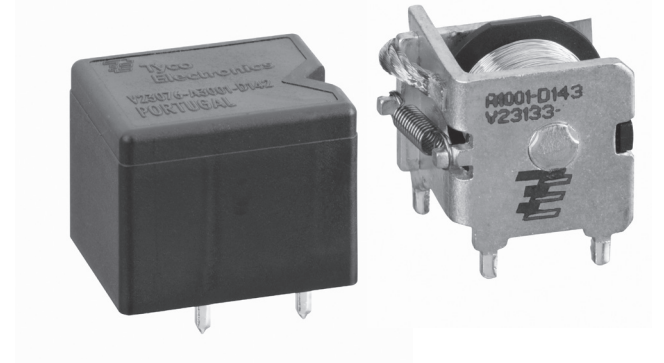

Contact Data

Typical applications	Resistive/inductive loads	Resistive/inductive loads	Indicator lamps	Headlights, capacitive loads	Headlights capacitive loads
Contact arrangement	1 form A, 1 NO	1 form C, 1 CO	1 form A, 1 NO	1 form A, 1 NO	1 form C, 1 CO
Rated voltage	12VDC	12VDC	12VDC	12VDC	12VDC
Rated current	45A	A/B (NO/NC)	30A	40A	A/B (NO/NC)
Limiting continuous current		45/30A			40/25A
23°C	45A	45/30A	30A	40A	40/25A
85°C	30A	30/25A	25A	25A	25/20A
Limiting making current ¹⁾	100A	100/30A	120A ³⁾	180A	180/60A
Limiting breaking current ²⁾	60A	60/30A	60A	60A	60/30A
Contact material	AgNi0.15	AgNi0.15	AgSnO ₂	AgSnO ₂	AgSnO ₂
Min. recommended contact load		1A at 5VDC ⁴⁾			
Initial voltage drop, at 10A, typ./max.		20/300mV			
Operate/release time		typ. 5/3ms ⁵⁾			
Electrical endurance	>2x10 ⁵ ops. at 13.5VDC, 40A	>2x10 ⁵ ops. at 13.5VDC, 40A	>2.2x10 ⁶ ops. up to 8x21W	>10 ⁵ ops. up to 4x60W	>10 ⁵ ops. up to 4x60W
Mechanical endurance, DC coil		>10 ⁷ ops.			

- 1) The values apply to a resistive or inductive load with suitable spark suppression and at maximum 13.5VDC for 12VDC or 27VDC for 24VDC load voltages.
- 2) For a load current duration of maximum 3s for a make/break ratio of 1:10.
- 3) Corresponds to a peak inrush current on initial actuation (cold filament).
- 4) See chapter Diagnostics of Relays in our Application Notes or consult the internet at <http://relays.te.com/appnotes/>
- 5) For unsuppressed relay coil. A low resistive suppression device in parallel to the relay coil increases the release time and reduces the lifetime caused by increased erosion and/or higher risk of contact tack welding.

Max. DC load breaking capacity

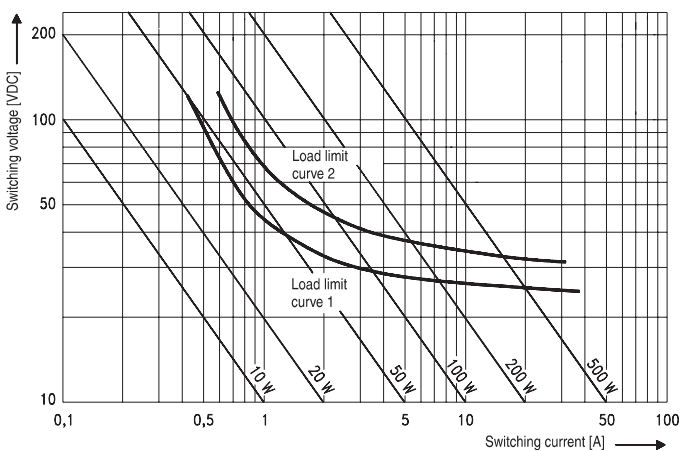

Load limit curve 1: arc extinguishes, during transit time (changeover contact).
 Load limit curve 2: safe shutdown, no stationary arc (make contact).
 Load limit curves measured with low inductive resistors verified for 1000 switching events.

Power Relay K (Open – Sealed) (Continued)

Coil Data

Rated coil voltage	12VDC / 24VDC
--------------------	---------------

Coil versions, DC coil

Coil code	Rated voltage VDC	Operate voltage VDC	Release voltage VDC	Coil resistance $\Omega \pm 10\%$	Rated coil power W
001	12	6.9	1.2	90	1.6
022	24	14.1	2.4	362	1.6

All figures are given for coil without pre-energization, at ambient temperature +23°C. Other coils on request.

Coil operating range

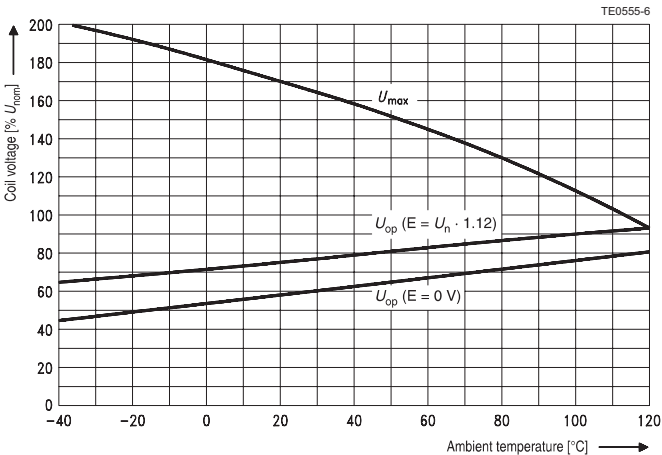

Does not take into account the temperature rise due to the contact current
E = pre-energization

Insulation Data

Initial dielectric strength	
between open contacts	500VAC _{rms}
between contact and coil	500VAC _{rms}

Other Data

EU RoHS/ELV compliance	compliant
Ambient temperature, DC coil	-40 to +85°C ⁶⁾
Climatic cycling with condensation, EN ISO 6988	3 cycles, storage 8/16h
Temperature cycling (shock), IEC 60068-2-14, Na	20 cycles, -40/+85°C (dwell time 1h)
Damp heat cyclic, IEC 60068-2-30, Db, Variant 1	6 cycles, upper air temperature 55°C
Damp heat constant, IEC 60068-2-3, method Ca	56 days, upper air temperature 55°C
Degree of protection, IEC 61810	RT 0/II – open version RT III – immersion cleanable version
Corrosive gas, IEC 60068-2-42	10 days
IEC 60068-2-43	10 days
Vibration resistance (functional), IEC 60068-2-6 (sine pulse form), acceleration, acc. to position	10 to 200Hz, 20 to 40g ⁷⁾
Shock resistance (functional), IEC 60068-2-27 (half sine form single pulses), acceleration, acc. to position	8ms 30g ⁷⁾
Terminal type	PCB
Weight	
sealed version	approx. 22g (0.77oz)
open version	approx. 19g (0.67oz)
Solderability (aging 3: 4h/155°C) for leaded process ($T_m = 183^\circ\text{C}$), for Pb-free process ($T_m = 217^\circ\text{C}$), IEC 60068-2-20	Ta, method 1, hot dip 5s, 215°C according IEC 600688 ⁸⁾
Storage conditions	
Packaging unit	
sealed version	525 pcs.
open version	500 pcs.

6) See coil operating range DC.

7) No change in the switching state >10 μ s.

8) For general storage and processing recommendations please refer to our Application Notes and especially to Storage in the Definitions or at <http://relays.te.com/appnotes/>

Terminal Assignment (Open and Sealed Version)

Bottom view on solder pins

1 form A, 1 NO

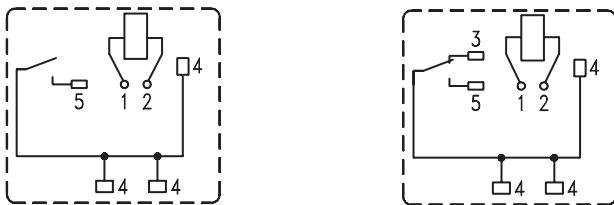

*) Terminal 4 to be bridged

Power Relay K (Open – Sealed) (Continued)

Dimensions

Power Relay K open version

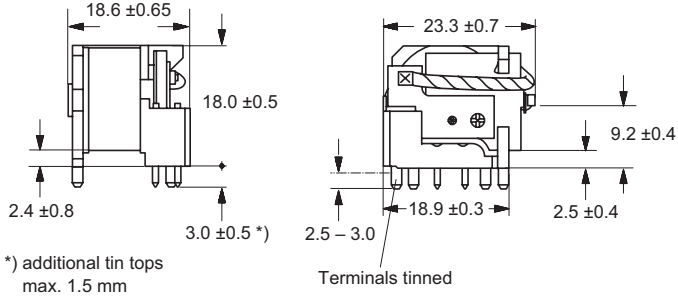

Power Relay K sealed version

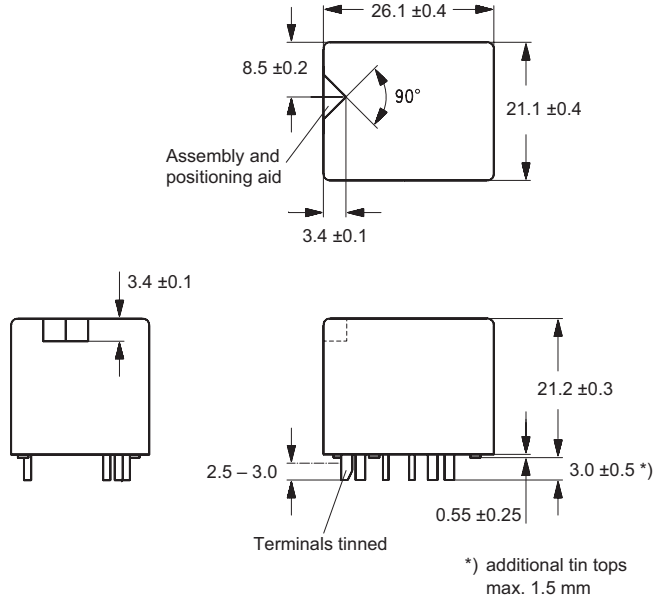

Mounting Hole Layout

Bottom view on solder pins

Power Relay K open version

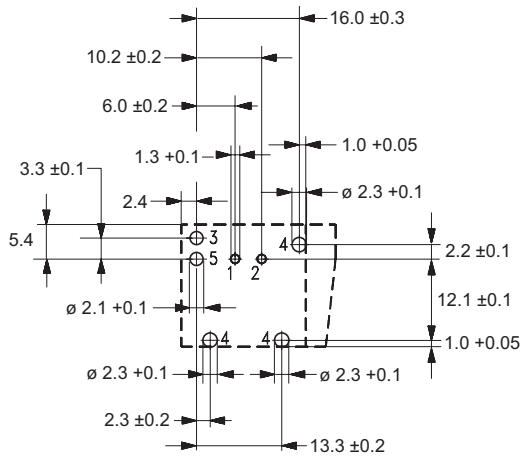

Power Relay K sealed version

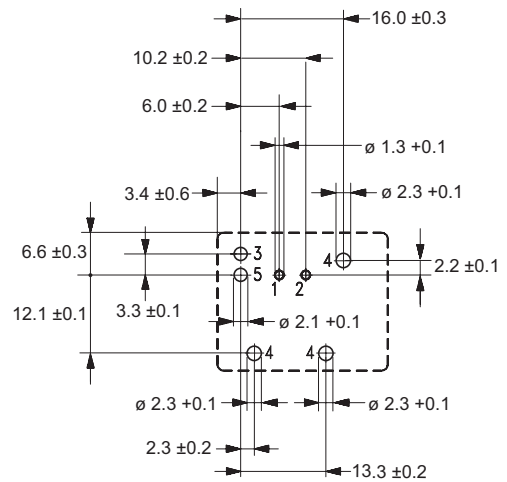

Power Relay K (Open – Sealed) (Continued)

Product code structure

Typical product code **V23076 -A 1 022 -C 13 3**

Type		V23076 Power Relay K, sealed		V23133 Power Relay K, open	
Terminal		A PCB			
Design		1 Single relay		3 Single relay	
Coil		001 12VDC		022 24VDC	
Contact type		C Single contact		D Single contact	
Contact material		13 AgNi0.15		14 AgSnO ₂	
		15 AgSnO ₂ (Special)			
Contact arrangement		2 1 form A, 1 NO		3 1 form C, 1 CO	

Product code	Terminal/Encl.	Design	Coil	Contact	Cont. material	Arrangement	Part number				
V23076-A1001-C133	PCB, sealed	Single relay	12VDC	Single	AgNi0.15	1 form C, CO	1393277-4				
V23076-A1001-D143					AgSnO ₂		1393277-6				
V23076-A3001-C132	PCB, open	Single relay	12VDC	Single	AgNi0.15	1 form A, NO	1-1393277-4				
V23076-A3001-D142					AgSnO ₂		1-1393277-7				
V23076-A3001-D152 ¹⁾					AgSnO ₂ special	1-1414175-0					
V23076-A1022-C133					24VDC	AgNi0.15	1393277-8				
V23076-A1022-D143						AgSnO ₂	1393277-9				
V23076-A3022-C132					24VDC	Single relay	12VDC	Single	AgNi0.15	1 form A, NO	1-1393277-8
V23076-A3022-D142									AgSnO ₂		1-1393277-9
V23133-A1001-C133									AgNi0.15	1393278-7	
V23133-A1001-D143									AgSnO ₂	1-1393278-3	
V23133-A3001-C132									AgNi0.15	5-1393278-7	
V23133-A3001-D142	AgSnO ₂	5-1393278-9									
V23133-A3001-D152 ¹⁾	AgSnO ₂ special	1-1414173-0									
V23133-A1022-C133	AgNi0.15	3-1393278-7									
V23133-A1022-D143	AgSnO ₂	3-1393278-9									
V23133-A3022-C132	1 form A, NO	AgNi0.15	7-1393278-1								
V23133-A3022-D142		AgSnO ₂	7-1393278-2								
V23133-A3022-D152 ¹⁾		AgSnO ₂ special	1-1414174-0								

1) For indicator lamps.