



Bridgelux® Gen 7 Vero® 13 Array

Product Data Sheet DSg1



Introduction

Vero® Series



Vero® Series is a revolutionary advancement in chip on board (COB) light source technology and innovation. Vero LED light sources simplify luminaire design and manufacturing processes. Vero Chip on Board (COB) LED arrays are available in four LES configurations, engineered to enable new degrees of flexibility and reliability over a broad range of electrical currents. Vero arrays deliver increased lumen density to enable improved beam control and precision lighting with 2 and 3 SDCM color control standard for clean and consistent uniform lighting.

Vero products include an onboard connector port that enables a solder-free electrical interconnect, and simple mounting features for plug-and-play installation.

Bridgelux Décor Series™ is our state-of-the-art color line designed specifically for premium applications, producing unmatched LED light quality with brilliant color-rendering options and pleasing lighting palettes. Bridgelux Décor Series color points are available on Vero® SE Series, Vero® Series, V Series™ and V Series™ HD.

Décor Series™ Class A is based on human response testing, providing color points with a combined GAI and CRI metric.

Décor Series™ Ultra products provide a high CRI of 97 and minimum R9 value of 93, which emphasizes the reds and color tones to which the human eye is most receptive - perfect for the most luxurious retail shops and world renowned museums. Décor Series Ultra is also designed as a replacement for halogen lamps.

Décor Series™ Showcase is the optimal solution for replacing ceramic metal halide lamps, incorporating the same pure white light with enhanced spectrum coverage and higher efficacy.

Features

- Efficacy of 160 lm/W typical
- Lumen output performance ranges from 460 to 7,300 lumens
- Broad range of CCT options from 2700K to 6500K
- CRI options include: minimum 70, 80, and 90
- 2 and 3 SDCM color control for 2700K-4000K CCT
- Reliable operation at up to 2X nominal drive current
- Radial die pattern and improved lumen density
- Thermally isolated solder pads
- Onboard connector port
- Top side part number markings
- V_f bin code backside marking

Benefits

- Broad application coverage for interior and exterior lighting
- Flexibility for application driven lighting design requirements
- High quality true color reproduction
- Uniform consistent white light
- Flexibility in design optimization
- Enhanced ease of use and assembly
- Solderless connectivity enables plug & play installation and field upgradability
- Improved inventory management and quality control



Contents

Product Feature Map	2
Product Nomenclature	2
Product Selection Guide	3
Performance at Commonly Used Drive Currents	10
Electrical Characteristics	19
Eye Safety	20
Absolute Maximum Ratings	21
Performance Curves	22
Typical Radiation Pattern	25
Typical Color Spectrum	26
Mechanical Dimensions	27
Color Binning Information	28
Packaging and Labeling	29
Design Resources	31
Precautions	31
Disclaimers	31
About Bridgelux	32

Product Feature Map

Vero 13 is the second smallest form factor in the Vero family of the next generation solid state light sources. In addition to delivering the performance and light quality required for many lighting applications, Vero incorporates

several features to simplify the design integration and manufacturing process, accelerate time to market and reduce system costs. Please visit www.bridgelux.com for more information on the Vero Series family of products.

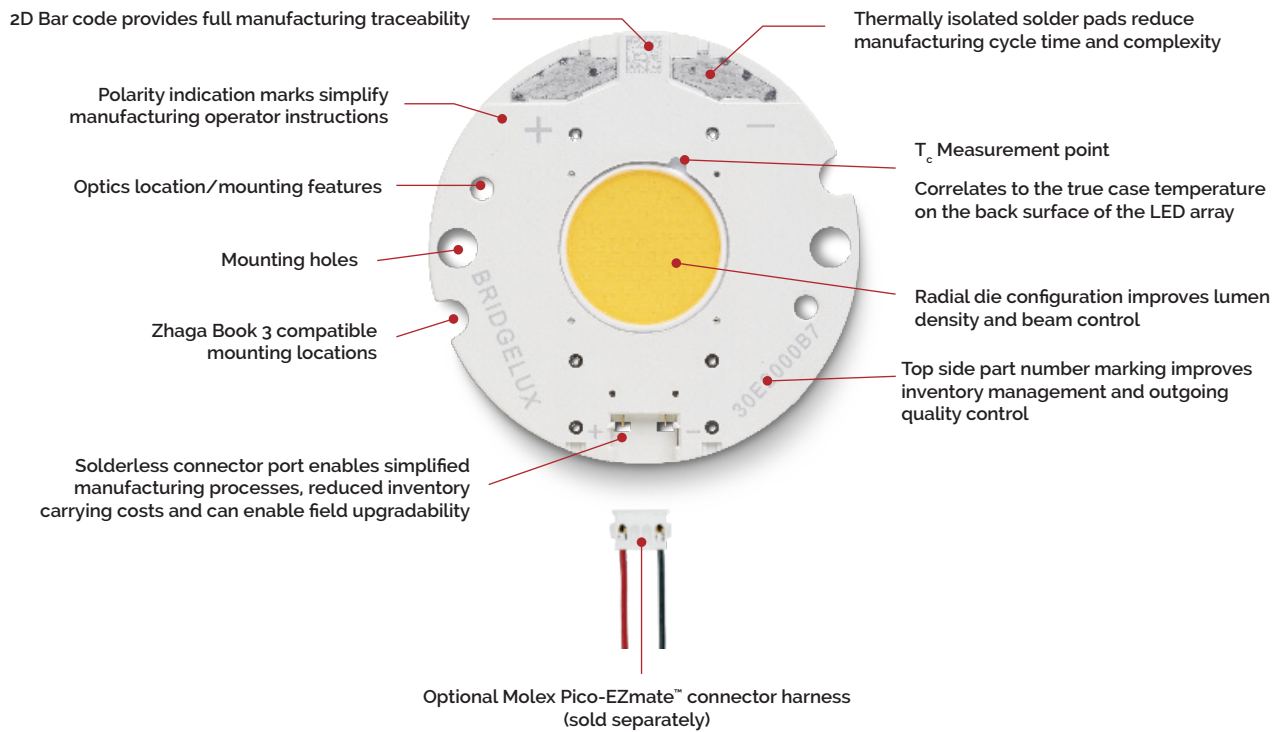

Product Nomenclature

The part number designation for Bridgelux Vero LED arrays is explained as follows:

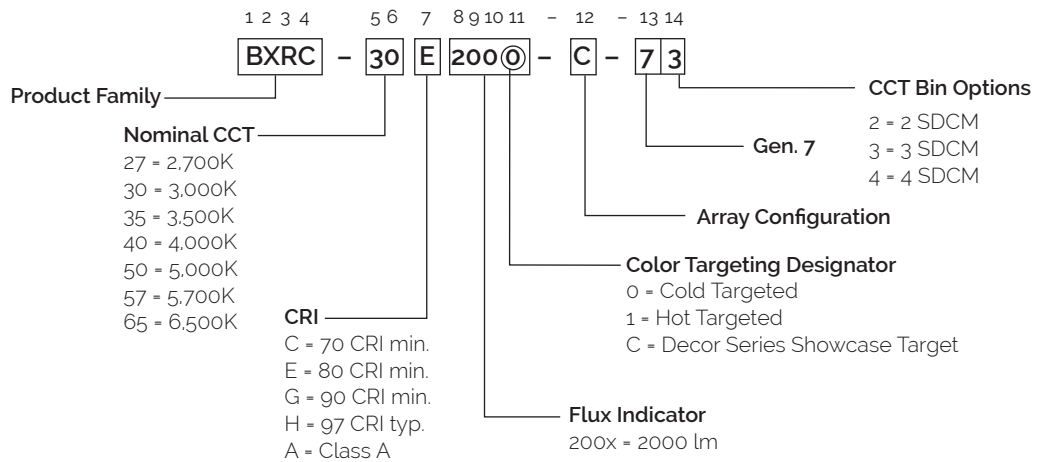

Product Selection Guide

The following product configurations are available:

Table 1: Selection Guide, Pulsed Measurement Data ($T_j = T_c = 25^\circ\text{C}$)

Part Number	Nominal CCT ¹ (K)	CRI ²	Nominal Drive Current ³ (mA)	Typical Pulsed Flux ^{4,5,6} $T_c = 25^\circ\text{C}$ (lm)	Minimum Pulsed Flux ^{6,7} $T_c = 25^\circ\text{C}$ (lm)	Typical V_f (V)	Typical Power (W)	Typical Efficacy (lm/W)
BXRC-27E2000-B-7x	2700	80	450	2403	2163	34.8	15.7	153
BXRC-27E2000-C-7x	2700	80	630	3365	3028	34.8	21.9	153
BXRC-27E2000-D-7x	2700	80	500	2440	2196	31.8	15.9	153
BXRC-27G20H0-B-7x	2700	90	450	2083	1875	34.8	15.7	133
BXRC-27G20H0-C-7x	2700	90	630	2916	2624	34.8	21.9	133
BXRC-27G20H0-D-7x	2700	90	500	2115	1903	31.8	15.9	133
BXRC-27G2000-B-7x	2700	90	450	2000	1800	34.8	15.7	128
BXRC-27G2000-C-7x	2700	90	630	2800	2520	34.8	21.9	128
BXRC-27G2000-D-7x	2700	90	500	2031	1828	31.8	15.9	128
BXRC-27H2000-B-7x	2700	97	450	1742	1568	34.8	15.7	111
BXRC-27H2000-C-7x	2700	97	630	2439	2195	34.8	21.9	111
BXRC-27H2000-D-7x	2700	97	500	1769	1592	31.8	15.9	111
BXRC-30C2001-B-74	3000	70	450	2756	2481	34.8	15.7	176
BXRC-30C2001-C-74	3000	70	630	3859	3473	34.8	21.9	176
BXRC-30C2001-D-74	3000	70	500	2798	2519	31.8	15.9	176
BXRC-30E2000-B-7x	3000	80	450	2500	2250	34.8	15.7	160
BXRC-30E2000-C-7x	3000	80	630	3500	3150	34.8	21.9	160
BXRC-30E2000-D-7x	3000	80	500	2538	2285	31.8	15.9	160
BXRC-30G20H0-B-7x	3000	90	450	2177	1959	34.8	15.7	139
BXRC-30G20H0-C-7x	3000	90	630	3047	2743	34.8	21.9	139
BXRC-30G20H0-D-7x	3000	90	500	2210	1989	31.8	15.9	139
BXRC-30G2000-B-7x	3000	90	450	2081	1873	34.8	15.7	133
BXRC-30G2000-C-7x	3000	90	630	2913	2622	34.8	21.9	133
BXRC-30G2000-D-7x	3000	90	500	2113	1901	31.8	15.9	133
BXRC-30G200C-B-73	3000	90	450	1947	1752	35.0	15.8	124
BXRC-30G200C-D-73	3000	90	500	1965	1769	31.8	15.9	124
BXRC-30H2000-B-7x	3000	97	450	1855	1669	34.8	15.7	118
BXRC-30H2000-C-7x	3000	97	630	2597	2337	34.8	21.9	118
BXRC-30H2000-D-7x	3000	97	500	1883	1695	31.8	15.9	118
BXRC-30A2001-B-73 ^{8,9}	3000	93	450	1879	1691	34.8	15.7	120
BXRC-30A2001-C-73 ^{8,9}	3000	93	630	2631	2368	34.8	21.9	120
BXRC-30A2001-D-73 ^{8,9}	3000	93	500	1908	1717	31.8	15.9	120

Notes for Table 1:

- Nominal CCT as defined by ANSI C78.377-2011. Products with a CCT of 5000K-6500K are hot targeted to $T_c = 85^\circ\text{C}$.
- CRI values are typical for Decor Series Ultra, Decor Series Street and Landmark and Decor Series Class A products. CRI values are minimums for all other products. Minimum Rg value for 80 CRI products is 0, the minimum Rg value for 90 CRI products is 50, the minimum Rg value for 97 CRI products is 93. Bridgelux maintains a ± 3 tolerance on CRI and Rg values.
- Drive current is referred to as nominal drive current.
- Products tested under pulsed condition (10ms pulse width) at nominal test current where T_j (junction temperature) - T_c (case temperature) = 25°C .
- Typical performance values are provided as a reference only and are not a guarantee of performance.
- Bridgelux maintains a $\pm 7\%$ tolerance on flux measurements.
- Minimum flux values at the nominal test current are guaranteed by 100% test.
- Nominal CCT is defined by the Lighting Research Center's Class A definition. The center of the Class A color bin is on the corresponding isothermal line.
- GAI value is 80. To help ensure optimal fixture level performance, GAI is measured at the fixture level, on axis, at a case temperature of 70°C . GAI may vary depending on fixture design and performance.

Product Selection Guide

Table 1: Selection Guide, Pulsed Measurement Data ($T_j = T_c = 25^\circ\text{C}$) (continued)

Part Number	Nominal CCT ¹ (K)	CRI ²	Nominal Drive Current ³ (mA)	Typical Pulsed Flux ^{4,5,6} $T_c = 25^\circ\text{C}$ (lm)	Minimum Pulsed Flux ^{6,7} $T_c = 25^\circ\text{C}$ (lm)	Typical V_f (V)	Typical Power (W)	Typical Efficacy (lm/W)
BXRC-35E2000-B-7x	3500	80	450	2581	2323	34.8	15.7	165
BXRC-35E2000-C-7x	3500	80	630	3613	3252	34.8	21.9	165
BXRC-35E2000-D-7x	3500	80	500	2620	2358	31.8	15.9	165
BXRC-35G2000-B-7x	3500	90	450	2145	1931	34.8	15.7	137
BXRC-35G2000-C-7x	3500	90	630	3003	2703	34.8	21.9	137
BXRC-35G2000-D-7x	3500	90	500	2178	1960	31.8	15.9	137
BXRC-35A2001-B-73 ^{8,9}	3500	93	450	2020	1818	34.8	15.7	129
BXRC-35A2001-C-73 ^{8,9}	3500	93	630	2828	2545	34.8	21.9	129
BXRC-35A2001-D-73 ^{8,9}	3500	93	500	2051	1846	31.8	15.9	129
BXRC-40C2001-B-74	4000	70	450	2803	2523	34.8	15.7	179
BXRC-40C2001-C-74	4000	70	630	3924	3532	34.8	21.9	179
BXRC-40C2001-D-74	4000	70	500	2846	2561	31.8	15.9	179
BXRC-40E2000-B-7x	4000	80	450	2597	2337	34.8	15.7	166
BXRC-40E2000-C-7x	4000	80	630	3636	3272	34.8	21.9	166
BXRC-40E2000-D-7x	4000	80	500	2637	2373	31.8	15.9	166
BXRC-40G2000-B-7x	4000	90	450	2226	2003	34.8	15.7	142
BXRC-40G2000-C-7x	4000	90	630	3116	2805	34.8	21.9	142
BXRC-40G2000-D-7x	4000	90	500	2260	2034	31.8	15.9	142
BXRC-40H2000-B-73	4000	97	450	1911	1719	34.8	15.7	122
BXRC-40H2000-C-73	4000	97	630	2675	2407	34.8	21.9	122
BXRC-40H2000-D-73	4000	97	500	1940	1746	31.8	15.9	122
BXRC-40A2001-B-73 ^{8,9}	4000	93	450	2161	1945	34.8	15.7	138
BXRC-40A2001-C-73 ^{8,9}	4000	93	630	3026	2723	34.8	21.9	138
BXRC-40A2001-D-73 ^{8,9}	4000	93	500	2194	1975	31.8	15.9	138
BXRC-50C2001-B-7x	5000	70	450	2855	2569	34.8	15.7	182
BXRC-50C2001-C-7x	5000	70	630	3997	3597	34.8	21.9	182
BXRC-50C2001-D-7x	5000	70	500	2899	2609	31.8	15.9	182
BXRC-50E2001-B-7x	5000	80	450	2678	2410	34.8	15.7	171
BXRC-50E2001-C-7x	5000	80	630	3749	3374	34.8	21.9	171
BXRC-50E2001-D-7x	5000	80	500	2719	2447	31.8	15.9	171
BXRC-50G2001-B-7x	5000	90	450	2274	2047	34.8	15.7	145
BXRC-50G2001-C-7x	5000	90	630	3184	2866	34.8	21.9	145
BXRC-50G2001-D-7x	5000	90	500	2309	2078	31.8	15.9	145

Notes for Table 1:

- Nominal CCT as defined by ANSI C78.377-2011. Products with a CCT of 5000K-6500K are hot targeted to $T_c = 85^\circ\text{C}$.
- CRI values are typical for Decor Series Ultra, Decor Series Street and Landmark and Decor Series Class A products. CRI values are minimums for all other products. Minimum Rg value for 80 CRI products is 0, the minimum Rg value for 90 CRI products is 50, the minimum Rg value for 97 CRI products is 93. Bridgelux maintains a ± 3 tolerance on CRI and Rg values.
- Drive current is referred to as nominal drive current.
- Products tested under pulsed condition (10ms pulse width) at nominal test current where T_j (junction temperature) - T_c (case temperature) = 25°C .
- Typical performance values are provided as a reference only and are not a guarantee of performance.
- Bridgelux maintains a $\pm 7\%$ tolerance on flux measurements.
- Minimum flux values at the nominal test current are guaranteed by 100% test.
- Nominal CCT is defined by the Lighting Research Center's Class A definition. The center of the Class A color bin is on the corresponding isothermal line.
- GAI value is 80. To help ensure optimal fixture level performance, GAI is measured at the fixture level, on axis, at a case temperature of 70°C . GAI may vary depending on fixture design and performance.

Product Selection Guide

Table 1: Selection Guide, Pulsed Measurement Data ($T_j = T_c = 25^\circ\text{C}$) (continued)

Part Number	Nominal CCT ¹ (K)	CRI ²	Nominal Drive Current ³ (mA)	Typical Pulsed Flux ^{4,5,6} $T_c = 25^\circ\text{C}$ (lm)	Minimum Pulsed Flux ^{6,7} $T_c = 25^\circ\text{C}$ (lm)	Typical V_f (V)	Typical Power (W)	Typical Efficacy (lm/W)
BXRC-57C2001-B-7x	5700	70	450	2758	2482	34.8	15.7	176
BXRC-57C2001-C-7x	5700	70	630	3861	3475	34.8	21.9	176
BXRC-57C2001-D-7x	5700	70	500	2800	2520	31.8	15.9	176
BXRC-57E2001-B-7x	5700	80	450	2647	2382	34.8	15.7	169
BXRC-57E2001-C-7x	5700	80	630	3705	3335	34.8	21.9	169
BXRC-57E2001-D-7x	5700	80	500	2687	2418	31.8	15.9	169
BXRC-65C2001-B-7x	6500	70	450	2807	2526	34.8	15.7	179
BXRC-65C2001-C-7x	6500	70	630	3929	3536	34.8	21.9	179
BXRC-65C2001-D-7x	6500	70	500	2850	2565	31.8	15.9	179
BXRC-65E2001-B-7x	6500	80	450	2694	2424	34.8	15.7	172
BXRC-65E2001-C-7x	6500	80	630	3771	3394	34.8	21.9	172
BXRC-65E2001-D-7x	6500	80	500	2735	2461	31.8	15.9	172

Notes for Table 1:

- Nominal CCT as defined by ANSI C78.377-2011. Products with a CCT of 5000K-6500K are hot targeted to $T_c = 85^\circ\text{C}$.
- CRI values are typical for Decor Series Ultra, Decor Series Street and Landmark and Decor Series Class A products. CRI values are minimums for all other products. Minimum Rg value for 80 CRI products is 0, the minimum Rg value for 90 CRI products is 50, the minimum Rg value for 97 CRI products is 93. Bridgelux maintains a ± 3 tolerance on CRI and Rg values.
- Drive current is referred to as nominal drive current.
- Products tested under pulsed condition (10ms pulse width) at nominal test current where T_j (junction temperature) - T_c (case temperature) = 25°C .
- Typical performance values are provided as a reference only and are not a guarantee of performance.
- Bridgelux maintains a $\pm 7\%$ tolerance on flux measurements.
- Minimum flux values at the nominal test current are guaranteed by 100% test.
- Nominal CCT is defined by the Lighting Research Center's Class A definition. The center of the Class A color bin is on the corresponding isothermal line.
- GAI value is 80. To help ensure optimal fixture level performance, GAI is measured at the fixture level, on axis, at a case temperature of 70°C . GAI may vary depending on fixture design and performance.

Product Selection Guide

Table 2: Selection Guide, Stabilized DC Performance ($T_c = 70^\circ\text{C}$) ^{7,8}

Part Number	Nominal CCT ¹ (K)	GAI ²	CRI ³	Nominal Drive Current ⁴ (mA)	Typical DC Flux ^{5,6} $T_c = 70^\circ\text{C}$ (lm)	Minimum DC Flux ^{6,9} $T_c = 70^\circ\text{C}$ (lm)	Typical V_f (V)	Typical Power (W)	Typical Efficacy (lm/W)
BXRC-30A2001-B-73	3000	80	93	450	1748	1573	34.4	15.5	113
BXRC-30A2001-C-73	3000	80	93	630	2447	2202	34.4	21.6	113
BXRC-30A2001-D-73	3000	80	93	500	1774	1597	31.2	15.6	114
BXRC-35A2001-B-73	3500	80	93	450	1879	1691	34.4	15.5	121
BXRC-35A2001-C-73	3500	80	93	630	2630	2367	34.4	21.6	121
BXRC-35A2001-D-73	3500	80	93	500	1908	1717	31.2	15.6	122
BXRC-40A2001-B-73	4000	80	93	450	2010	1809	34.4	15.5	130
BXRC-40A2001-C-73	4000	80	93	630	2814	2532	34.4	21.6	130
BXRC-40A2001-D-73	4000	80	93	500	2041	1837	31.2	15.6	131

Notes for Table 2:

- Nominal CCT is defined by the Lighting Research Center's Class A definition. The center of the Class A color bin is on the corresponding isothermal line.
- To help ensure optimal fixture level performance, GAI is measured at the fixture level, on axis, at a case temperature of 70°C . GAI may vary depending on fixture design and performance.
- CRI Values are specified as typical.
- Drive current is referred to as nominal drive current.
- Typical performance values are provided as a reference only and are not a guarantee of performance.
- Bridgelux maintains a $\pm 7\%$ tolerance on flux measurements.
- Typical stabilized DC performance values are provided as reference only and are not a guarantee of performance.
- Typical performance is estimated based on operation under DC (direct current) with LED array mounted onto a heat sink with thermal interface material and the case temperature maintained at specified temperature. Based on Bridgelux test setup, values may vary depending on the thermal design of the luminaire and/or the exposed environment to which the product is subjected.
- Minimum flux values at elevated temperatures are provided for reference only and are not guaranteed by 100% production testing. Based on Bridgelux test setup, values may vary depending on the thermal design of the luminaire and/or the exposed environment to which the product is subjected.

Product Selection Guide

Table 3: Selection Guide, Stabilized DC Performance ($T_c = 85^\circ\text{C}$)^{4,5}

Part Number	Nominal CCT ¹ (K)	CRI ²	Nominal Drive Current ³ (mA)	Typical DC Flux ^{4,5} $T_c = 85^\circ\text{C}$ (lm)	Minimum DC Flux ⁶ $T_c = 85^\circ\text{C}$ (lm)	Typical V_f (V)	Typical Power (W)	Typical Efficacy (lm/W)
BXRC-27E2000-B-7x	2700	80	450	2163	1947	33.9	15.3	142
BXRC-27E2000-C-7x	2700	80	630	3028	2725	33.9	21.4	142
BXRC-27E2000-D-7x	2700	80	500	2196	1977	30.9	15.5	142
BXRC-27G20H0-B-7x	2700	90	450	1875	1687	33.9	15.3	123
BXRC-27G20H0-C-7x	2700	90	630	2624	2362	33.9	21.4	123
BXRC-27G20H0-D-7x	2700	90	500	1903	1713	30.9	15.5	123
BXRC-27G2000-B-7x	2700	90	450	1800	1620	33.9	15.3	118
BXRC-27G2000-C-7x	2700	90	630	2520	2268	33.9	21.4	118
BXRC-27G2000-D-7x	2700	90	500	1828	1645	30.9	15.5	118
BXRC-27H2000-B-7x	2700	97	450	1568	1411	33.9	15.3	103
BXRC-27H2000-C-7x	2700	97	630	2195	1975	33.9	21.4	103
BXRC-27H2000-D-7x	2700	97	500	1592	1433	30.9	15.5	103
BXRC-30C2001-B-74	3000	70	450	2481	2232	33.9	15.3	163
BXRC-30C2001-C-74	3000	70	630	3473	3125	33.9	21.4	163
BXRC-30C2001-D-74	3000	70	500	2519	2267	30.9	15.5	163
BXRC-30E2000-B-7x	3000	80	450	2250	2025	33.9	15.3	147
BXRC-30E2000-C-7x	3000	80	630	3150	2835	33.9	21.4	147
BXRC-30E2000-D-7x	3000	80	500	2285	2056	30.9	15.5	148
BXRC-30G20H0-B-7x	3000	90	450	1959	1763	33.9	15.3	128
BXRC-30G20H0-C-7x	3000	90	630	2743	2468	33.9	21.4	128
BXRC-30G20H0-D-7x	3000	90	500	1989	1790	30.9	15.5	129
BXRC-30G2000-B-7x	3000	90	450	1873	1685	33.9	15.3	123
BXRC-30G2000-C-7x	3000	90	630	2622	2360	33.9	21.4	123
BXRC-30G2000-D-7x	3000	90	500	1901	1711	30.9	15.5	123
BXRC-30G200C-B-73	3000	90	450	1752	1577	34.1	15.3	114
BXRC-30G200C-D-73	3000	90	500	1769	1592	30.9	15.5	114
BXRC-30H2000-B-7x	3000	97	450	1669	1502	33.9	15.3	109
BXRC-30H2000-C-7x	3000	97	630	2337	2103	33.9	21.4	109
BXRC-30H2000-D-7x	3000	97	500	1695	1526	30.9	15.5	110
BXRC-30A2001-B-7x ^{7,8}	3000	93	450	1691	1522	33.9	15.3	111
BXRC-30A2001-C-7x ^{7,8}	3000	93	630	2368	2131	33.9	21.4	111
BXRC-30A2001-D-7x ^{7,8}	3000	93	500	1717	1545	30.9	15.5	111

Notes for Table 3:

- Nominal CCT as defined by ANSI C78.377-2011. Products with a CCT of 5000K-6500K are hot targeted to $T_c = 85^\circ\text{C}$.
- All CRI values are measured at $T_c = T_a = 25^\circ\text{C}$. CRI values are typical for Decor Series Ultra, Decor Series Street and Landmark and Decor Series Class A products. CRI values are minimums for all other products. Minimum Rg value for 80 CRI products is 0, the minimum Rg value for 90 CRI products is 50, the minimum Rg value for 97 CRI products is 93. Bridgelux maintains a ± 3 tolerance on CRI and Rg values.
- Drive current is referred to as nominal drive current.
- Typical stabilized DC performance values are provided as reference only and are not a guarantee of performance.
- Typical performance is estimated based on operation under DC (direct current) with LED array mounted onto a heat sink with thermal interface material and the case temperature maintained at 85°C . Based on Bridgelux test setup, values may vary depending on the thermal design of the luminaire and/or the exposed environment to which the product is subjected.
- Minimum flux values at elevated temperatures are provided for reference only and are not guaranteed by 100% production testing. Based on Bridgelux test setup, values may vary depending on the thermal design of the luminaire and/or the exposed environment to which the product is subjected.
- Nominal CCT is defined by the Lighting Research Center's Class A definition. The center of the Class A color bin is on the corresponding isothermal line.
- GAI value is 80. To help ensure optimal fixture level performance, GAI is measured at the fixture level, on axis, at a case temperature of 70°C . GAI may vary depending on fixture design and performance.

Product Selection Guide

Table 3: Selection Guide, Stabilized DC Performance ($T_c = 85^\circ\text{C}$)^{4,5} (continued)

Part Number	Nominal CCT ¹ (K)	CRI ²	Nominal Drive Current ³ (mA)	Typical DC Flux ^{4,5} $T_c = 85^\circ\text{C}$ (lm)	Minimum DC Flux ⁶ $T_c = 85^\circ\text{C}$ (lm)	Typical V_f (V)	Typical Power (W)	Typical Efficacy (lm/W)
BXRC-35E2000-B-7x	3500	80	450	2323	2090	33.9	15.3	152
BXRC-35E2000-C-7x	3500	80	630	3252	2927	33.9	21.4	152
BXRC-35E2000-D-7x	3500	80	500	2358	2122	30.9	15.5	152
BXRC-35G2000-B-7x	3500	90	450	1931	1738	33.9	15.3	127
BXRC-35G2000-C-7x	3500	90	630	2703	2433	33.9	21.4	127
BXRC-35G2000-D-7x	3500	90	500	1960	1764	30.9	15.5	127
BXRC-35A2001-B-73 ^{7,8}	3500	93	450	1818	1636	33.9	15.3	119
BXRC-35A2001-C-73 ^{7,8}	3500	93	630	2545	2291	33.9	21.4	119
BXRC-35A2001-D-73 ^{7,8}	3500	93	500	1846	1661	30.9	15.5	119
BXRC-40C2001-B-74	4000	70	450	2523	2271	33.9	15.3	165
BXRC-40C2001-C-74	4000	70	630	3532	3179	33.9	21.4	165
BXRC-40C2001-D-74	4000	70	500	2561	2305	30.9	15.5	166
BXRC-40E2000-B-7x	4000	80	450	2337	2103	33.9	15.3	153
BXRC-40E2000-C-7x	4000	80	630	3272	2945	33.9	21.4	153
BXRC-40E2000-D-7x	4000	80	500	2373	2136	30.9	15.5	153
BXRC-40G2000-B-7x	4000	90	450	2003	1803	33.9	15.3	131
BXRC-40G2000-C-7x	4000	90	630	2805	2524	33.9	21.4	131
BXRC-40G2000-D-7x	4000	90	500	2034	1831	30.9	15.5	132
BXRC-40H2000-B-73	4000	97	450	1719	1548	33.9	15.3	113
BXRC-40H2000-C-73	4000	97	630	2407	2167	33.9	21.4	113
BXRC-40H2000-D-73	4000	97	500	1746	1571	30.9	15.5	113
BXRC-40A2001-B-73 ^{7,8}	4000	93	450	1945	1750	33.9	15.3	127
BXRC-40A2001-C-73 ^{7,8}	4000	93	630	2723	2451	33.9	21.4	127
BXRC-40A2001-D-73 ^{7,8}	4000	93	500	1975	1777	30.9	15.5	128
BXRC-50C2001-B-7x	5000	70	450	2569	2313	33.9	15.3	168
BXRC-50C2001-C-7x	5000	70	630	3597	3238	33.9	21.4	168
BXRC-50C2001-D-7x	5000	70	500	2609	2348	30.9	15.5	169
BXRC-50E2001-B-7x	5000	80	450	2410	2169	33.9	15.3	158
BXRC-50E2001-C-7x	5000	80	630	3374	3036	33.9	21.4	158
BXRC-50E2001-D-7x	5000	80	500	2447	2202	30.9	15.5	158
BXRC-50G2001-B-7x	5000	90	450	2047	1842	33.9	15.3	134
BXRC-50G2001-C-7x	5000	90	630	2866	2579	33.9	21.4	134
BXRC-50G2001-D-7x	5000	90	500	2078	1870	30.9	15.5	134

Notes for Table 3:

- Nominal CCT as defined by ANSI C78.377-2011. Products with a CCT of 5000K-6500K are hot targeted to $T_c = 85^\circ\text{C}$.
- All CRI values are measured at $T_c = 25^\circ\text{C}$. CRI values are typical for Decor Series Ultra, Decor Series Street and Landmark and Decor Series Class A products. CRI values are minimums for all other products. Minimum R_g value for 80 CRI products is 0, the minimum R_g value for 90 CRI products is 50, the minimum R_g value for 97 CRI products is 93. Bridgelux maintains a ± 3 tolerance on CRI and R_g values.
- Drive current is referred to as nominal drive current.
- Typical stabilized DC performance values are provided as reference only and are not a guarantee of performance.
- Typical performance is estimated based on operation under DC (direct current) with LED array mounted onto a heat sink with thermal interface material and the case temperature maintained at 85°C . Based on Bridgelux test setup, values may vary depending on the thermal design of the luminaire and/or the exposed environment to which the product is subjected.
- Minimum flux values at elevated temperatures are provided for reference only and are not guaranteed by 100% production testing. Based on Bridgelux test setup, values may vary depending on the thermal design of the luminaire and/or the exposed environment to which the product is subjected.
- Nominal CCT is defined by the Lighting Research Center's Class A definition. The center of the Class A color bin is on the corresponding isothermal line.
- GAI value is 80. To help ensure optimal fixture level performance, GAI is measured at the fixture level, on axis, at a case temperature of 70°C . GAI may vary depending on fixture design and performance.

Product Selection Guide

Table 3: Selection Guide, Stabilized DC Performance ($T_c = 85^\circ\text{C}$)^{4,5}

Part Number	Nominal CCT ¹ (K)	CRI ²	Nominal Drive Current ³ (mA)	Typical DC Flux ^{4,5} $T_c = 85^\circ\text{C}$ (lm)	Minimum DC Flux ⁶ $T_c = 85^\circ\text{C}$ (lm)	Typical V_f (V)	Typical Power (W)	Typical Efficacy (lm/W)
BXRC-57C2001-B-7x	5700	70	450	2482	2234	33.9	15.3	163
BXRC-57C2001-C-7x	5700	70	630	3475	3128	33.9	21.4	163
BXRC-57C2001-D-7x	5700	70	500	2520	2268	30.9	15.5	163
BXRC-57E2001-B-7x	5700	80	450	2382	2144	33.9	15.3	156
BXRC-57E2001-C-7x	5700	80	630	3335	3001	33.9	21.4	156
BXRC-57E2001-D-7x	5700	80	500	2418	2177	30.9	15.5	156
BXRC-65C2001-B-7x	6500	70	450	2526	2273	33.9	15.3	166
BXRC-65C2001-C-7x	6500	70	630	3536	3183	33.9	21.4	166
BXRC-65C2001-D-7x	6500	70	500	2565	2308	30.9	15.5	166
BXRC-65E2001-B-7x	6500	80	450	2424	2182	33.9	15.3	159
BXRC-65E2001-C-7x	6500	80	630	3394	3054	33.9	21.4	159
BXRC-65E2001-D-7x	6500	80	500	2461	2215	30.9	15.5	159

Notes for Table 3:

- Nominal CCT as defined by ANSI C78.377-2011. Products with a CCT of 5000K-6500K are hot targeted to $T_c = 85^\circ\text{C}$.
- All CRI values are measured at $T_c = T_a = 25^\circ\text{C}$. CRI values are typical for Decor Series Ultra, Decor Series Street and Landmark and Decor Series Class A products. CRI values are minimums for all other products. Minimum R9 value for 80 CRI products is 0, the minimum R9 value for 90 CRI products is 50, the minimum R9 value for 97 CRI products is g3. Bridgelux maintains a ± 3 tolerance on CRI and R9 values.
- Drive current is referred to as nominal drive current.
- Typical stabilized DC performance values are provided as reference only and are not a guarantee of performance.
- Typical performance is estimated based on operation under DC (direct current) with LED array mounted onto a heat sink with thermal interface material and the case temperature maintained at 85°C . Based on Bridgelux test setup, values may vary depending on the thermal design of the luminaire and/or the exposed environment to which the product is subjected.
- Minimum flux values at elevated temperatures are provided for reference only and are not guaranteed by 100% production testing. Based on Bridgelux test setup, values may vary depending on the thermal design of the luminaire and/or the exposed environment to which the product is subjected.
- Nominal CCT is defined by the Lighting Research Center's Class A definition. The center of the Class A color bin is on the corresponding isothermal line.
- GAI value is 80. To help ensure optimal fixture level performance, GAI is measured at the fixture level, on axis, at a case temperature of 70°C . GAI may vary depending on fixture design and performance.

Performance at Commonly Used Drive Currents

Vero LED arrays are tested to the specifications shown using the nominal drive currents in Table 1. Vero may also be driven at other drive currents dependent on specific application design requirements. The performance at any drive current can be derived from the current vs. voltage characteristics shown in Figures 1, 2 & 3 and the flux vs. current characteristics shown in Figures 4, 5 & 6. The performance at commonly used drive currents is summarized in Table 4.

Table 4: Product Performance at Commonly Used Drive Currents

Part Number	CRI	Drive Current ¹ (mA)	Typical V_f $T_c = 25^\circ\text{C}$ (V)	Typical Power $T_c = 25^\circ\text{C}$ (W)	Typical Flux ² $T_c = 25^\circ\text{C}$ (lm)	Typical DC Flux ³ $T_c = 85^\circ\text{C}$ (lm)	Typical Efficacy $T_c = 25^\circ\text{C}$ (lm/W)
BXRC-27E2000-B-7x	80	113	33.2	3.7	655	600	175
		225	34.0	7.7	1267	1149	166
		450	34.8	15.7	2403	2163	153
		675	35.6	24.1	3473	3042	144
		900	36.1	32.5	4430	3805	136
BXRC-27E2000-C-7x	80	158	33.2	5.2	909	859	174
		315	34.0	10.7	1760	1657	164
		630	34.8	21.9	3365	3028	153
		945	35.6	33.7	4829	4515	143
		1260	36.1	45.5	6164	5743	135
BXRC-27E2000-D-7x	80	125	29.6	3.7	646	617	175
		250	30.3	7.6	1252	1193	165
		500	31.8	15.9	2440	2196	153
		750	33.2	24.9	3448	3267	139
		1000	34.4	34.4	4409	4167	128
BXRC-27G20H0-B-7x	90	113	33.2	3.7	567	520	152
		225	34.0	7.7	1098	996	143
		450	34.8	15.7	2083	1875	133
		675	35.6	24.1	3010	2636	125
		900	36.1	32.5	3839	3298	118
BXRC-27G20H0-C-7x	90	158	33.2	5.2	788	745	151
		315	34.0	10.7	1525	1436	142
		630	34.8	21.9	2916	2624	133
		945	35.6	33.7	4185	3913	124
		1260	36.1	45.5	5342	4977	117
BXRC-27G20H0-D-7x	90	125	29.6	3.7	560	535	152
		250	30.3	7.6	1085	1034	143
		500	31.8	15.9	2115	1903	133
		750	33.2	24.9	2988	2831	120
		1000	34.4	34.4	3821	3611	111
BXRC-27G2000-B-7x	90	113	33.2	3.7	545	499	146
		225	34.0	7.7	1054	956	138
		450	34.8	15.7	2000	1800	128
		675	35.6	24.1	2890	2531	120
		900	36.1	32.5	3687	3167	113
BXRC-27G2000-C-7x	90	158	33.2	5.2	757	715	145
		315	34.0	10.7	1465	1379	137
		630	34.8	21.9	2800	2520	128
		945	35.6	33.7	4019	3757	119
		1260	36.1	45.5	5130	4779	113

Notes for Table 4:

1. Alternate drive currents are provided for reference only and are not a guarantee of performance.
2. Bridgelux maintains a $\pm 7\%$ tolerance on flux measurements.
3. Typical stabilized DC performance values are provided as reference only and are not a guarantee of performance.

Performance at Commonly Used Drive Currents

Table 4: Product Performance at Commonly Used Drive Currents (Continued)

Part Number	CRI	Drive Current ¹ (mA)	Typical V _f T _c = 25°C (V)	Typical Power T _c = 25°C (W)	Typical Flux ² T _c = 25°C (lm)	Typical DC Flux ³ T _c = 85°C (lm)	Typical Efficacy T _c = 25°C (lm/W)
BXRC-27G2000-D-7x	90	125	29.6	3.7	538	513	146
		250	30.3	7.6	1042	993	137
		500	31.8	15.9	2031	1828	128
		750	33.2	24.9	2870	2719	115
		1000	34.4	34.4	3669	3468	107
BXRC-27H2000-B-7x	97	113	33.2	3.7	474	435	127
		225	34.0	7.7	918	833	120
		450	34.8	15.7	1742	1568	111
		675	35.6	24.1	2517	2205	105
		900	36.1	32.5	3211	2758	99
BXRC-27H2000-C-7x	97	158	33.2	5.2	659	623	126
		315	34.0	10.7	1276	1201	119
		630	34.8	21.9	2439	2195	111
		945	35.6	33.7	3500	3272	104
		1260	36.1	45.5	4468	4163	98
BXRC-27H2000-D-7x	97	125	29.6	3.7	468	447	127
		250	30.3	7.6	908	864	120
		500	31.8	15.9	1769	1592	111
		750	33.2	24.9	2499	2368	100
		1000	34.4	34.4	3196	3020	93
BXRC-30C2001-B-74	70	113	33.2	3.7	751	688	201
		225	34.0	7.7	1453	1318	190
		450	34.8	15.7	2756	2481	176
		675	35.6	24.1	3983	3488	166
		900	36.1	32.5	5081	4364	156
BXRC-30C2001-C-74	70	158	33.2	5.2	1043	986	199
		315	34.0	10.7	2018	1901	188
		630	34.8	21.9	3859	3473	176
		945	35.6	33.7	5538	5177	164
		1260	36.1	45.5	7069	6586	155
BXRC-30C2001-D-74	70	125	29.6	3.7	741	707	201
		250	30.3	7.6	1436	1368	189
		500	31.8	15.9	2798	2519	176
		750	33.2	24.9	3955	3746	159
		1000	34.4	34.4	5056	4778	147
BXRC-30E2000-B-7x	80	113	33.2	3.7	681	624	182
		225	34.0	7.7	1318	1195	172
		450	34.8	15.7	2500	2250	160
		675	35.6	24.1	3613	3164	150
		900	36.1	32.5	4609	3959	142
BXRC-30E2000-C-7x	80	158	33.2	5.2	946	894	181
		315	34.0	10.7	1831	1724	171
		630	34.8	21.9	3500	3150	160
		945	35.6	33.7	5024	4697	149
		1260	36.1	45.5	6412	5974	141

Notes for Table 4:

1. Alternate drive currents are provided for reference only and are not a guarantee of performance.
2. Bridgelux maintains a ± 7% tolerance on flux measurements.
3. Typical stabilized DC performance values are provided as reference only and are not a guarantee of performance.

Performance at Commonly Used Drive Currents

Table 4: Product Performance at Commonly Used Drive Currents (Continued)

Part Number	CRI	Drive Current ¹ (mA)	Typical V _f T _c = 25°C (V)	Typical Power T _c = 25°C (W)	Typical Flux ² T _c = 25°C (lm)	Typical DC Flux ³ T _c = 85°C (lm)	Typical Efficacy T _c = 25°C (lm/W)
BXRC-30E2000-D-7x	80	125	29.6	3.7	672	642	182
		250	30.3	7.6	1303	1241	172
		500	31.8	15.9	2538	2285	160
		750	33.2	24.9	3587	3398	144
		1000	34.4	34.4	4587	4334	133
BXRC-30G20H0-B-7x	90	113	33.2	3.7	593	543	159
		225	34.0	7.7	1147	1041	150
		450	34.8	15.7	2177	1959	139
		675	35.6	24.1	3146	2755	131
		900	36.1	32.5	4013	3447	123
BXRC-30G20H0-C-7x	90	158	33.2	5.2	823	778	157
		315	34.0	10.7	1594	1501	149
		630	34.8	21.9	3047	2743	139
		945	35.6	33.7	4374	4089	130
		1260	36.1	45.5	5583	5202	123
BXRC-30G20H0-D-7x	90	125	29.6	3.7	585	559	158
		250	30.3	7.6	1134	1080	150
		500	31.8	15.9	2210	1989	139
		750	33.2	24.9	3123	2959	125
		1000	34.4	34.4	3993	3774	116
BXRC-30G2000-B-7x	90	113	33.2	3.7	567	519	152
		225	34.0	7.7	1097	995	143
		450	34.8	15.7	2081	1873	133
		675	35.6	24.1	3007	2633	125
		900	36.1	32.5	3836	3295	118
BXRC-30G2000-C-7x	90	158	33.2	5.2	787	744	150
		315	34.0	10.7	1524	1435	142
		630	34.8	21.9	2913	2622	133
		945	35.6	33.7	4181	3909	124
		1260	36.1	45.5	5336	4972	117
BXRC-30G2000-D-7x	90	125	29.6	3.7	559	534	151
		250	30.3	7.6	1084	1033	143
		500	31.8	15.9	2113	1901	133
		750	33.2	24.9	2985	2828	120
		1000	34.4	34.4	3817	3607	111
BXRC-30G200C-B-73	90	113	33.2	3.7	530	486	142
		225	34.0	7.7	1026	931	134
		450	34.8	15.7	1947	1752	124
		675	35.6	24.1	2813	2464	117
		900	36.1	32.5	3589	3082	110
BXRC-30G200C-D-73	90	125	29.6	3.7	520	497	141
		250	30.3	7.6	1008	961	133
		500	31.8	15.9	1965	1769	124
		750	33.2	24.9	2777	2631	112
		1000	34.4	34.4	3551	3356	103

Notes for Table 4:

1. Alternate drive currents are provided for reference only and are not a guarantee of performance.
2. Bridgelux maintains a ± 7% tolerance on flux measurements.
3. Typical stabilized DC performance values are provided as reference only and are not a guarantee of performance.

Performance at Commonly Used Drive Currents

Table 4: Product Performance at Commonly Used Drive Currents (Continued)

Part Number	CRI	Drive Current ¹ (mA)	Typical V _f T _c = 25°C (V)	Typical Power T _c = 25°C (W)	Typical Flux ² T _c = 25°C (lm)	Typical DC Flux ³ T _c = 85°C (lm)	Typical Efficacy T _c = 25°C (lm/W)
BXRC-30H2000-B-7x	97	113	33.2	3.7	505	463	135
		225	34.0	7.7	978	887	128
		450	34.8	15.7	1855	1669	118
		675	35.6	24.1	2681	2348	111
		900	36.1	32.5	3419	2937	105
BXRC-30H2000-C-7x	97	158	33.2	5.2	702	663	134
		315	34.0	10.7	1358	1279	127
		630	34.8	21.9	2597	2337	118
		945	35.6	33.7	3727	3485	111
		1260	36.1	45.5	4757	4433	104
BXRC-30H2000-D-7x	97	125	29.6	3.7	499	476	135
		250	30.3	7.6	966	920	127
		500	31.8	15.9	1883	1695	118
		750	33.2	24.9	2661	2521	107
		1000	34.4	34.4	3403	3216	99
BXRC-30A2001-B-73	93	113	33.2	3.7	512	469	137
		225	34.0	7.7	991	898	129
		450	34.8	15.7	1879	1691	120
		675	35.6	24.1	2716	2378	113
		900	36.1	32.5	3464	2976	106
BXRC-30A2001-C-73	93	158	33.2	5.2	711	672	136
		315	34.0	10.7	1376	1296	128
		630	34.8	21.9	2631	2368	120
		945	35.6	33.7	3776	3530	112
		1260	36.1	45.5	4819	4491	106
BXRC-30A2001-D-73	93	125	29.6	3.7	505	482	137
		250	30.3	7.6	979	933	129
		500	31.8	15.9	1908	1717	120
		750	33.2	24.9	2696	2554	108
		1000	34.4	34.4	3448	3258	100
BXRC-35E2000-B-7x	80	113	33.2	3.7	703	644	188
		225	34.0	7.7	1360	1234	178
		450	34.8	15.7	2581	2323	165
		675	35.6	24.1	3730	3266	155
		900	36.1	32.5	4757	4086	146
BXRC-35E2000-C-7x	80	158	33.2	5.2	976	923	187
		315	34.0	10.7	1890	1780	176
		630	34.8	21.9	3613	3252	165
		945	35.6	33.7	5186	4848	154
		1260	36.1	45.5	6619	6167	145
BXRC-35E2000-D-7x	80	125	29.6	3.7	694	662	188
		250	30.3	7.6	1345	1281	177
		500	31.8	15.9	2620	2358	165
		750	33.2	24.9	3703	3508	149
		1000	34.4	34.4	4735	4474	138

Notes for Table 4:

1. Alternate drive currents are provided for reference only and are not a guarantee of performance.
2. Bridgelux maintains a ± 7% tolerance on flux measurements.
3. Typical stabilized DC performance values are provided as reference only and are not a guarantee of performance.

Performance at Commonly Used Drive Currents

Table 4: Product Performance at Commonly Used Drive Currents (Continued)

Part Number	CRI	Drive Current ¹ (mA)	Typical V _f T _c = 25°C (V)	Typical Power T _c = 25°C (W)	Typical Flux ² T _c = 25°C (lm)	Typical DC Flux ³ T _c = 85°C (lm)	Typical Efficacy T _c = 25°C (lm/W)
BXRC-35G2000-B-7x	90	113	33.2	3.7	584	535	156
		225	34.0	7.7	1131	1026	148
		450	34.8	15.7	2145	1931	137
		675	35.6	24.1	3100	2715	129
		900	36.1	32.5	3955	3397	122
BXRC-35G2000-C-7x	90	158	33.2	5.2	811	767	155
		315	34.0	10.7	1571	1479	147
		630	34.8	21.9	3003	2703	137
		945	35.6	33.7	4311	4030	128
		1260	36.1	45.5	5502	5126	121
BXRC-35G2000-D-7x	90	125	29.6	3.7	577	551	156
		250	30.3	7.6	1118	1065	147
		500	31.8	15.9	2178	1960	137
		750	33.2	24.9	3078	2916	124
		1000	34.4	34.4	3936	3719	114
BXRC-35A2001-B-73	93	113	33.2	3.7	550	504	147
		225	34.0	7.7	1065	966	139
		450	34.8	15.7	2020	1818	129
		675	35.6	24.1	2919	2557	121
		900	36.1	32.5	3724	3199	114
BXRC-35A2001-C-73	93	158	33.2	5.2	764	722	146
		315	34.0	10.7	1479	1393	138
		630	34.8	21.9	2828	2545	129
		945	35.6	33.7	4059	3795	121
		1260	36.1	45.5	5181	4827	114
BXRC-35A2001-D-73	93	125	29.6	3.7	543	519	147
		250	30.3	7.6	1053	1002	139
		500	31.8	15.9	2051	1846	129
		750	33.2	24.9	2899	2746	116
		1000	34.4	34.4	3706	3502	108
BXRC-40C2001-B-74	70	113	33.2	3.7	763	700	204
		225	34.0	7.7	1478	1340	193
		450	34.8	15.7	2803	2523	179
		675	35.6	24.1	4051	3548	168
		900	36.1	32.5	5167	4438	159
BXRC-40C2001-C-74	70	158	33.2	5.2	1060	1002	203
		315	34.0	10.7	2053	1933	192
		630	34.8	21.9	3924	3532	179
		945	35.6	33.7	5633	5266	167
		1260	36.1	45.5	7189	6698	158
BXRC-40C2001-D-74	70	125	29.6	3.7	753	720	204
		250	30.3	7.6	1460	1391	193
		500	31.8	15.9	2846	2561	179
		750	33.2	24.9	4022	3810	162
		1000	34.4	34.4	5143	4860	149

Notes for Table 4:

1. Alternate drive currents are provided for reference only and are not a guarantee of performance.
2. Bridgelux maintains a ± 7% tolerance on flux measurements.
3. Typical stabilized DC performance values are provided as reference only and are not a guarantee of performance.

Performance at Commonly Used Drive Currents

Table 4: Product Performance at Commonly Used Drive Currents (Continued)

Part Number	CRI	Drive Current ¹ (mA)	Typical V _f T _c = 25°C (V)	Typical Power T _c = 25°C (W)	Typical Flux ² T _c = 25°C (lm)	Typical DC Flux ³ T _c = 85°C (lm)	Typical Efficacy T _c = 25°C (lm/W)
BXRC-40E2000-B-7x	80	113	33.2	3.7	707	648	189
		225	34.0	7.7	1369	1242	179
		450	34.8	15.7	2597	2337	166
		675	35.6	24.1	3753	3287	156
		900	36.1	32.5	4787	4112	147
BXRC-40E2000-C-7x	80	158	33.2	5.2	982	929	188
		315	34.0	10.7	1902	1791	178
		630	34.8	21.9	3636	3272	166
		945	35.6	33.7	5218	4878	155
		1260	36.1	45.5	6660	6206	146
BXRC-40E2000-D-7x	80	125	29.6	3.7	698	667	189
		250	30.3	7.6	1353	1289	178
		500	31.8	15.9	2637	2373	166
		750	33.2	24.9	3726	3530	150
		1000	34.4	34.4	4764	4502	138
BXRC-40G2000-B-7x	90	113	33.2	3.7	606	556	162
		225	34.0	7.7	1173	1064	153
		450	34.8	15.7	2226	2003	142
		675	35.6	24.1	3217	2817	134
		900	36.1	32.5	4103	3525	126
BXRC-40G2000-C-7x	90	158	33.2	5.2	842	796	161
		315	34.0	10.7	1630	1535	152
		630	34.8	21.9	3116	2805	142
		945	35.6	33.7	4473	4181	133
		1260	36.1	45.5	5709	5319	125
BXRC-40G2000-D-7x	90	125	29.6	3.7	598	571	162
		250	30.3	7.6	1160	1105	153
		500	31.8	15.9	2260	2034	142
		750	33.2	24.9	3194	3026	128
		1000	34.4	34.4	4084	3859	119
BXRC-40H2000-B-7x	97	113	33.2	3.7	520	477	139
		225	34.0	7.7	1007	913	132
		450	34.8	15.7	1911	1719	122
		675	35.6	24.1	2761	2418	115
		900	36.1	32.5	3522	3025	108
BXRC-40H2000-C-7x	97	158	33.2	5.2	723	683	138
		315	34.0	10.7	1399	1317	131
		630	34.8	21.9	2675	2407	122
		945	35.6	33.7	3839	3589	114
		1260	36.1	45.5	4900	4565	108
BXRC-40H2000-D-7x	97	125	29.6	3.7	513	490	139
		250	30.3	7.6	995	948	131
		500	31.8	15.9	1940	1746	122
		750	33.2	24.9	2741	2597	110
		1000	34.4	34.4	3505	3312	102

Notes for Table 4:

1. Alternate drive currents are provided for reference only and are not a guarantee of performance.
2. Bridgelux maintains a ± 7% tolerance on flux measurements.
3. Typical stabilized DC performance values are provided as reference only and are not a guarantee of performance.

Performance at Commonly Used Drive Currents

Table 4: Product Performance at Commonly Used Drive Currents (Continued)

Part Number	CRI	Drive Current ¹ (mA)	Typical V_f $T_c = 25^\circ\text{C}$ (V)	Typical Power $T_c = 25^\circ\text{C}$ (W)	Typical Flux ² $T_c = 25^\circ\text{C}$ (lm)	Typical DC Flux ³ $T_c = 85^\circ\text{C}$ (lm)	Typical Efficacy $T_c = 25^\circ\text{C}$ (lm/W)
BXRC-40A2001-B-73	93	113	33.2	3.7	589	539	158
		225	34.0	7.7	1139	1033	149
		450	34.8	15.7	2161	1945	138
		675	35.6	24.1	3123	2735	130
		900	36.1	32.5	3984	3422	122
BXRC-40A2001-C-73	93	158	33.2	5.2	817	773	156
		315	34.0	10.7	1583	1490	148
		630	34.8	21.9	3026	2723	138
		945	35.6	33.7	4343	4060	129
		1260	36.1	45.5	5542	5164	122
BXRC-40A2001-D-73	93	125	29.6	3.7	581	555	157
		250	30.3	7.6	1126	1072	148
		500	31.8	15.9	2194	1975	138
		750	33.2	24.9	3101	2937	125
		1000	34.4	34.4	3965	3747	115
BXRC-50C2001-B-7x	70	113	33.2	3.7	778	713	208
		225	34.0	7.7	1505	1365	197
		450	34.8	15.7	2855	2569	182
		675	35.6	24.1	4126	3613	172
		900	36.1	32.5	5263	4521	162
BXRC-50C2001-C-7x	70	158	33.2	5.2	1080	1021	206
		315	34.0	10.7	2091	1969	195
		630	34.8	21.9	3997	3597	182
		945	35.6	33.7	5737	5363	170
		1260	36.1	45.5	7322	6822	161
BXRC-50C2001-D-7x	70	125	29.6	3.7	767	733	208
		250	30.3	7.6	1487	1417	196
		500	31.8	15.9	2899	2609	182
		750	33.2	24.9	4096	3881	165
		1000	34.4	34.4	5238	4950	152
BXRC-50E2001-B-7x	80	113	33.2	3.7	729	668	195
		225	34.0	7.7	1411	1280	184
		450	34.8	15.7	2678	2410	171
		675	35.6	24.1	3869	3389	161
		900	36.1	32.5	4936	4240	152
BXRC-50E2001-C-7x	80	158	33.2	5.2	1013	958	194
		315	34.0	10.7	1961	1846	183
		630	34.8	21.9	3749	3374	171
		945	35.6	33.7	5380	5030	160
		1260	36.1	45.5	6867	6398	151
BXRC-50E2001-D-7x	80	125	29.6	3.7	720	687	195
		250	30.3	7.6	1395	1329	184
		500	31.8	15.9	2719	2447	171
		750	33.2	24.9	3842	3640	154
		1000	34.4	34.4	4912	4642	143

Notes for Table 4:

1. Alternate drive currents are provided for reference only and are not a guarantee of performance.
2. Bridgelux maintains a $\pm 7\%$ tolerance on flux measurements.
3. Typical stabilized DC performance values are provided as reference only and are not a guarantee of performance.

Performance at Commonly Used Drive Currents

Table 4: Product Performance at Commonly Used Drive Currents (Continued)

Part Number	CRI	Drive Current ¹ (mA)	Typical V_f $T_c = 25^\circ\text{C}$ (V)	Typical Power $T_c = 25^\circ\text{C}$ (W)	Typical Flux ² $T_c = 25^\circ\text{C}$ (lm)	Typical DC Flux ³ $T_c = 85^\circ\text{C}$ (lm)	Typical Efficacy $T_c = 25^\circ\text{C}$ (lm/W)
BXRC-50G2001-B-7x	90	113	33.2	3.7	619	568	166
		225	34.0	7.7	1199	1087	157
		450	34.8	15.7	2274	2047	145
		675	35.6	24.1	3287	2878	137
		900	36.1	32.5	4192	3601	129
BXRC-50G2001-C-7x	90	158	33.2	5.2	860	813	164
		315	34.0	10.7	1665	1568	155
		630	34.8	21.9	3184	2866	145
		945	35.6	33.7	4570	4272	136
		1260	36.1	45.5	5833	5435	128
BXRC-50G2001-D-7x	90	125	29.6	3.7	611	584	165
		250	30.3	7.6	1185	1129	156
		500	31.8	15.9	2309	2078	145
		750	33.2	24.9	3263	3091	131
		1000	34.4	34.4	4172	3943	121
BXRC-57C2001-B-7x	70	113	33.2	3.7	751	688	201
		225	34.0	7.7	1454	1319	190
		450	34.8	15.7	2758	2482	176
		675	35.6	24.1	3986	3491	166
		900	36.1	32.5	5084	4367	156
BXRC-57C2001-C-7x	70	158	33.2	5.2	1043	986	199
		315	34.0	10.7	2020	1902	189
		630	34.8	21.9	3861	3475	176
		945	35.6	33.7	5542	5181	165
		1260	36.1	45.5	7074	6591	155
BXRC-57C2001-D-7x	70	125	29.6	3.7	741	708	201
		250	30.3	7.6	1437	1369	189
		500	31.8	15.9	2800	2520	176
		750	33.2	24.9	3957	3749	159
		1000	34.4	34.4	5060	4782	147
BXRC-57E2001-B-7x	80	113	33.2	3.7	721	661	193
		225	34.0	7.7	1395	1265	182
		450	34.8	15.7	2647	2382	169
		675	35.6	24.1	3825	3349	159
		900	36.1	32.5	4879	4191	150
BXRC-57E2001-C-7x	80	158	33.2	5.2	1001	946	191
		315	34.0	10.7	1938	1825	181
		630	34.8	21.9	3705	3335	169
		945	35.6	33.7	5318	4972	158
		1260	36.1	45.5	6787	6324	149
BXRC-57E2001-D-7x	80	125	29.6	3.7	711	679	193
		250	30.3	7.6	1379	1313	182
		500	31.8	15.9	2687	2418	169
		750	33.2	24.9	3797	3597	153
		1000	34.4	34.4	4855	4588	141

Notes for Table 4:

1. Alternate drive currents are provided for reference only and are not a guarantee of performance.
2. Bridgelux maintains a $\pm 7\%$ tolerance on flux measurements.
3. Typical stabilized DC performance values are provided as reference only and are not a guarantee of performance.

Performance at Commonly Used Drive Currents

Table 4: Product Performance at Commonly Used Drive Currents (Continued)

Part Number	CRI	Drive Current ¹ (mA)	Typical V_f $T_c = 25^\circ\text{C}$ (V)	Typical Power $T_c = 25^\circ\text{C}$ (W)	Typical Flux ² $T_c = 25^\circ\text{C}$ (lm)	Typical DC Flux ³ $T_c = 85^\circ\text{C}$ (lm)	Typical Efficacy $T_c = 25^\circ\text{C}$ (lm/W)
BXRC-65C2001-B-7x	70	113	33.2	3.7	764	700	205
		225	34.0	7.7	1479	1342	193
		450	34.8	15.7	2807	2526	179
		675	35.6	24.1	4056	3552	169
		900	36.1	32.5	5174	4444	159
BXRC-65C2001-C-7x	70	158	33.2	5.2	1062	1004	203
		315	34.0	10.7	2055	1935	192
		630	34.8	21.9	3929	3536	179
		945	35.6	33.7	5640	5272	167
		1260	36.1	45.5	7198	6707	158
BXRC-65C2001-D-7x	70	125	29.6	3.7	754	720	204
		250	30.3	7.6	1462	1393	193
		500	31.8	15.9	2850	2565	179
		750	33.2	24.9	4027	3815	162
		1000	34.4	34.4	5149	4866	150
BXRC-65E2001-B-7x	80	113	33.2	3.7	734	672	196
		225	34.0	7.7	1420	1288	186
		450	34.8	15.7	2694	2424	172
		675	35.6	24.1	3893	3409	162
		900	36.1	32.5	4965	4265	153
BXRC-65E2001-C-7x	80	158	33.2	5.2	1019	963	195
		315	34.0	10.7	1972	1857	184
		630	34.8	21.9	3771	3394	172
		945	35.6	33.7	5412	5060	161
		1260	36.1	45.5	6908	6437	152
BXRC-65E2001-D-7x	80	125	29.6	3.7	724	691	196
		250	30.3	7.6	1403	1337	185
		500	31.8	15.9	2735	2461	172
		750	33.2	24.9	3865	3661	155
		1000	34.4	34.4	4942	4670	144

Notes for Table 4:

1. Alternate drive currents are provided for reference only and are not a guarantee of performance.
2. Bridgelux maintains a $\pm 7\%$ tolerance on flux measurements.
3. Typical stabilized DC performance values are provided as reference only and are not a guarantee of performance.

Electrical Characteristics

Table 5: Electrical Characteristics

Part Number	Drive Current (mA)	Forward Voltage Pulsed, $T_c = 25^\circ\text{C}$ (V) ^{1, 2, 3, 8}			Typical Coefficient of Forward Voltage ⁴ $\Delta V_f / \Delta T_c$ (mV/ $^\circ\text{C}$)	Typical Thermal Resistance Junction to Case ^{5,6} R_{j-c} ($^\circ\text{C}/\text{W}$)	Driver Selection Voltages ⁷ (V)	
		Minimum	Typical	Maximum			V_f Min. Hot $T_c = 105^\circ\text{C}$ (V)	V_f Max. Cold $T_c = -40^\circ\text{C}$ (V)
BXRC-xxx200x-B-7x	450	32.2	34.8	37.4	-14.3	0.28	31.0	38.3
	900	33.4	36.1	38.8	-14.3	0.35	32.2	39.7
BXRC-xxx200x-C-7x	630	32.2	34.8	37.4	-14.3	0.20	31.0	38.3
	1260	33.4	36.1	38.8	-14.3	0.24	32.2	39.7
BXRC-xxx200x-D-7x	500	29.4	31.8	34.2	-13.3	0.34	28.4	35.0
	1000	31.8	34.4	37.0	-13.3	0.41	30.8	37.9

Notes for Table 5:

- Parts are tested in pulsed conditions, $T_c = 25^\circ\text{C}$. Pulse width is 10ms.
- Voltage minimum and maximum are provided for reference only and are not a guarantee of performance.
- Bridgelux maintains a tester tolerance of $\pm 0.10\text{V}$ on forward voltage measurements.
- Typical coefficient of forward voltage tolerance is $\pm 0.1\text{mV}$ for nominal current.
- Thermal resistance values are based from test data of a 3000K 80 CRI product.
- Thermal resistance value was calculated using total electrical input power; optical power was not subtracted from input power. The thermal interface material used during testing is not included in the thermal resistance value.
- V_f min hot and max cold values are provided as reference only and are not guaranteed by test. These values are provided to aid in driver design and selection over the operating range of the product.
- This product has been designed and manufactured per IEC 62031:2014. This product has passed dielectric withstand voltage testing at 1160 V. The working voltage designated for the insulation is 80V d.c. The maximum allowable voltage across the array must be determined in the end product application.

Eye Safety

Table 6: Eye Safety Risk Group (RG) Classifications

Part Number	Drive Current ⁵ (mA)	CCT ⁵			
		2700K/3000K	4000K ²	5000K ³	6500K ⁴
BXRC-xxx200x-B-7x	450	RG1	RG1	RG1	RG1
	675	RG1	RG1	RG1	RG2
	900	RG1	RG1	RG2	RG2
BXRC-xxx200x-C-7x	630	RG1	RG1	RG1	RG1
	945	RG1	RG1	RG2	RG2
	1260	RG1	RG2	RG2	RG2
BXRC-xxx200x-D-7x	500	RG1	RG1	RG1	RG1
	750	RG1	RG1	RG1	RG2
	1000	RG1	RG1	RG2	RG2

Notes for Table 6:

1. Eye safety classification for the use of Bridgelux Vero Series LED arrays is in accordance with specification IEC/TR 62778: Application of IEC 62471 for the assessment of blue light hazard to light sources and luminaires.
2. For products classified as RG2 at 4000K, $E_{thr} = 1847.5$ lx.
3. For products classified as RG2 at 5000K $E_{thr} = 1315.8$ lx.
4. For products classified as RG2 at 6500K, $E_{thr} = 1124.5$ lx.
5. Please contact your Bridgelux sales representative for E_{thr} values at specific drive currents and CCTs not listed.

Absolute Maximum Ratings

Table 7: Maximum Ratings

Parameter	Maximum Rating		
LED Junction Temperature (T_j)	150°C		
Storage Temperature	-40°C to +105°C		
Operating Case Temperature ¹ (T_c)	105°C		
Soldering Temperature ²	300°C or lower for a maximum of 6 seconds		
	BXRC-xxx200x-B-7x	BXRC-xxx200x-C-7x	BXRC-xxx200x-D-7x
Maximum Drive Current ³	900mA	1260mA	1000mA
Maximum Peak Pulsed Drive Current ⁴	1290mA	1800mA	1430mA
Maximum Reverse Voltage ⁵	-60V	-60V	-55V

Notes for Table 7:

1. For IEC 62717 requirement, please consult your Bridgelux sales representative.
2. Refer to Bridgelux Application Note AN31: Assembly Considerations for Bridgelux Vero LED Arrays.
3. Arrays may be driven at higher currents however lumen maintenance may be reduced.
4. Bridgelux recommends a maximum duty cycle of 10% and pulse width of 20 ms when operating LED Arrays at maximum peak pulsed current specified. Maximum peak pulsed currents indicate values where LED Arrays can be driven without catastrophic failures.
5. Light emitting diodes are not designed to be driven in reverse voltage and will not produce light under this condition. Maximum rating provided for reference only.

Performance Curves

Figure 1: Vero 13B Drive Current vs. Voltage

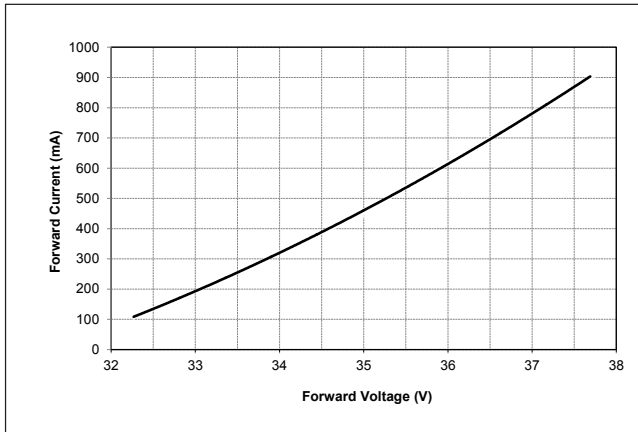

Figure 2: Vero 13C Drive Current vs. Voltage

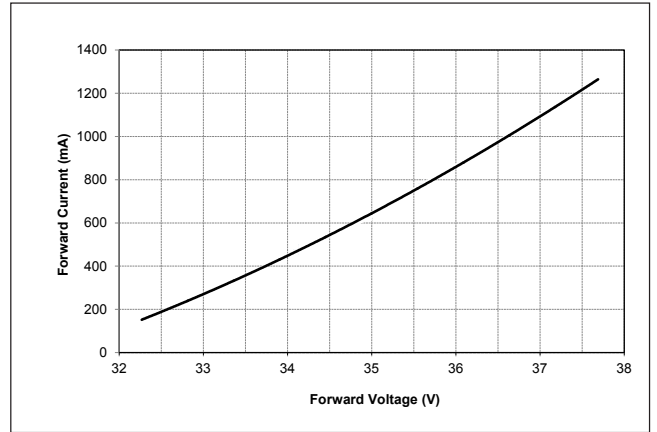

Figure 3: Vero 13D Drive Current vs. Voltage

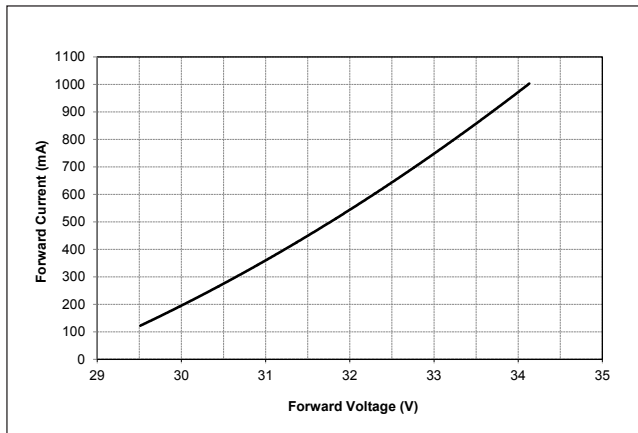

Figure 4: Vero 13B Typical Relative Flux vs. Current

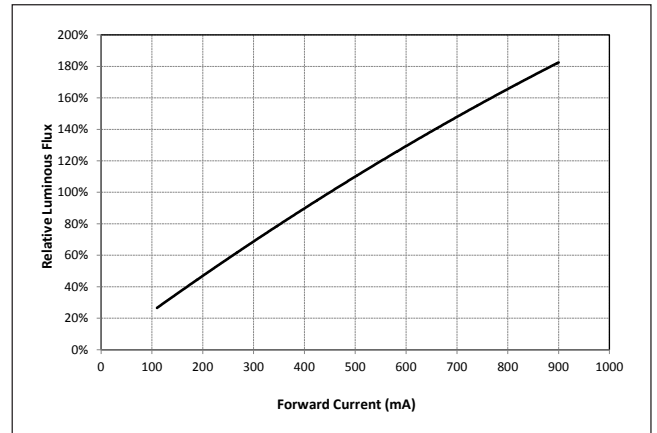

Figure 5: Vero 13C Typical Relative Flux vs. Current

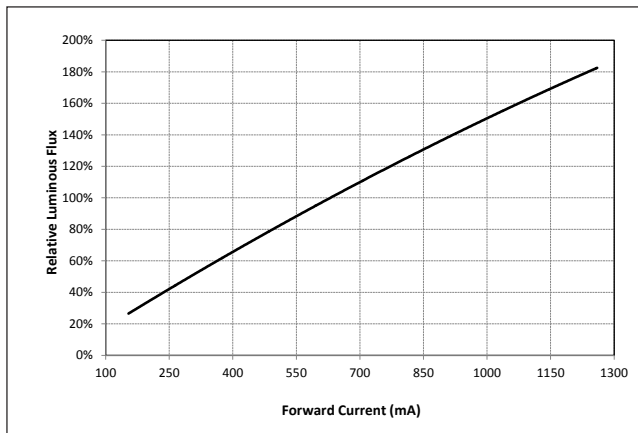
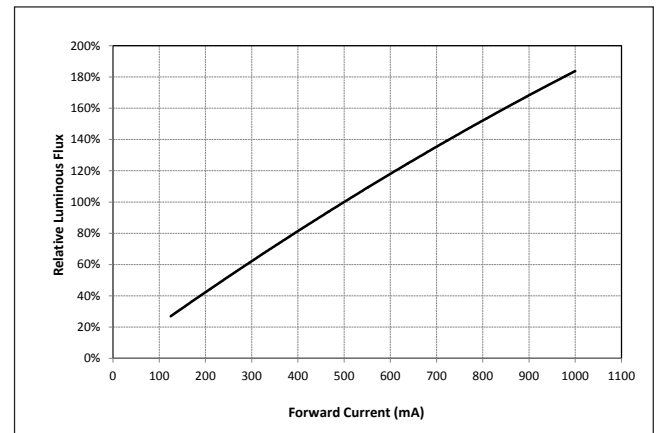

Figure 6: Vero 13D Typical Relative Flux vs. Current



Note for Figure 1-6:

1. Bridgelux does not recommend driving high power LEDs at low currents. Doing so may produce unpredictable results. Pulse width modulation (PWM) is recommended for dimming effects.
2. Products tested under pulsed condition (10ms pulse width) at nominal test current where T_j (junction temperature) - T_c (case temperature) = 25°C.

Performance Curves

Figure 7: Typical DC Flux vs. Case Temperature

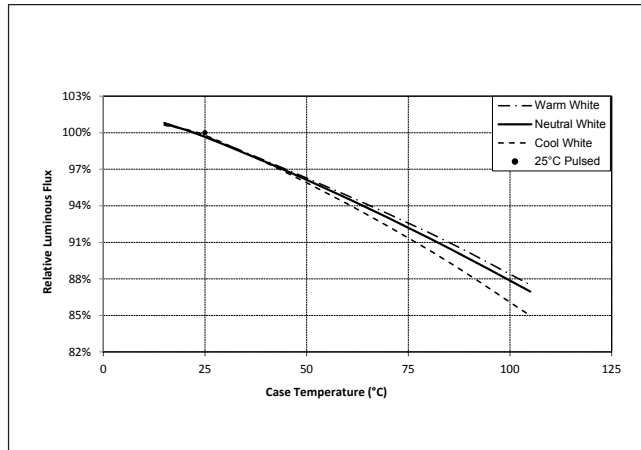

Figure 8: Typical DC ccy Shift vs. Case Temperature

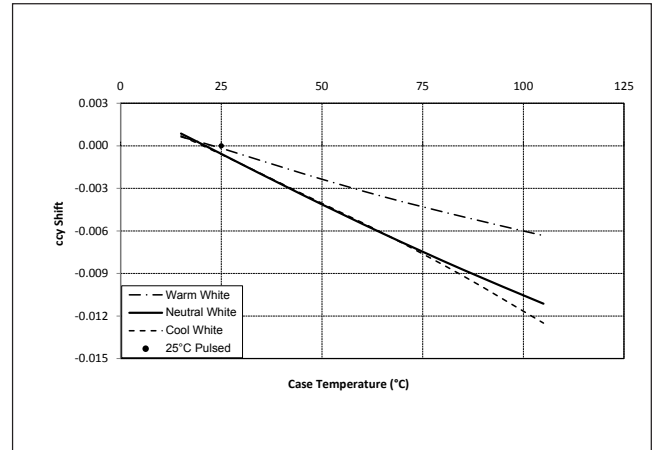
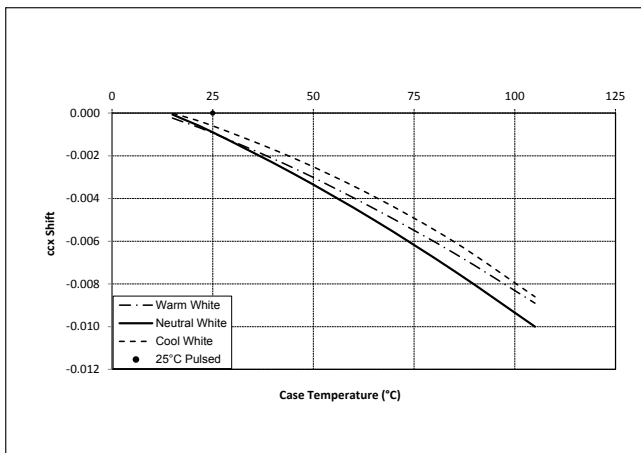

Figure 9: Typical DC ccx Shift vs. Case Temperature



Notes for Figures 7-9:

1. Characteristics shown for warm white based on 3000K and 80 CRI.
2. Characteristics shown for neutral white based on 4000K and 80 CRI.
3. Characteristics shown for cool white based on 5000K and 70 CRI.
4. For other color SKUs, the shift in color will vary. Please contact your Bridgelux Sales Representative for more information.

Performance Curves

Figure 10: 2700K, 97 CRI Color Shift vs. Case Temperature¹

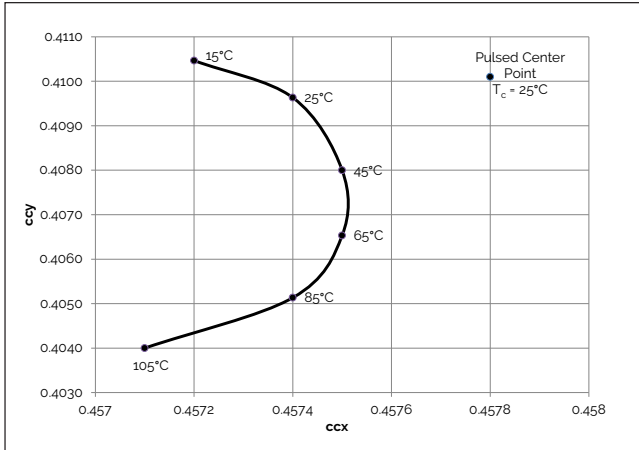

Figure 11: 3000K, 97 CRI Color Shift vs. Case Temperature¹

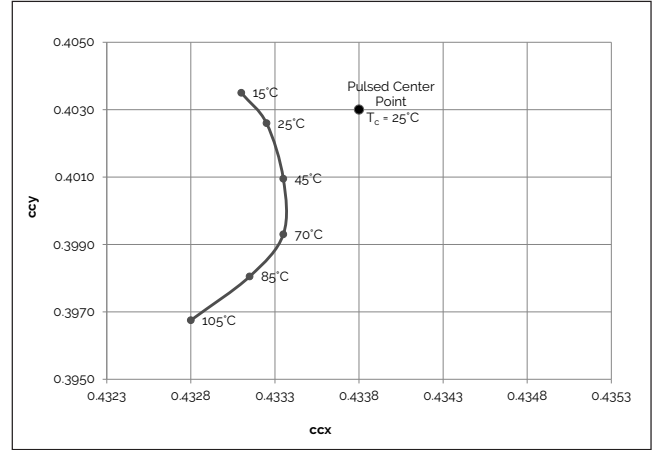

Figure 12: 3000K, 90 CRI Color Shift vs. Case Temperature¹

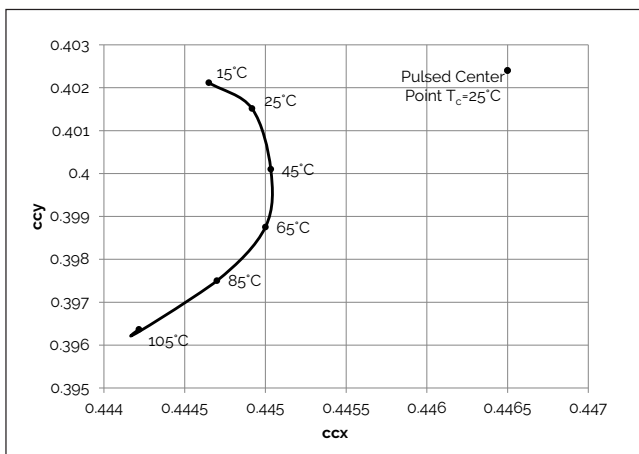

Figure 13: 3000K Class A Color Shift vs. Case Temperature¹

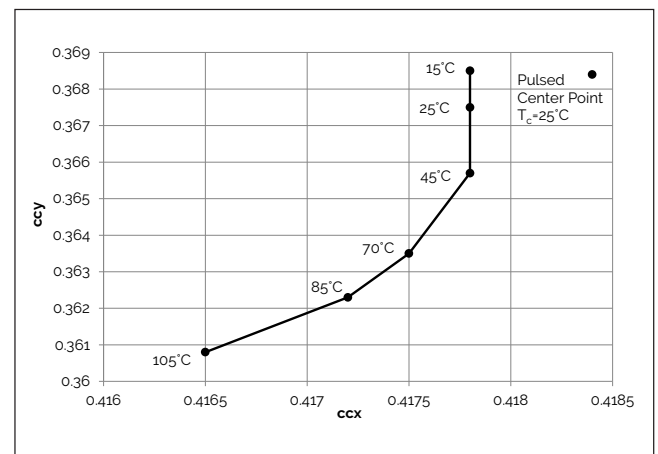

Figure 14: 3500K Class A Color Shift vs. Case Temperature¹

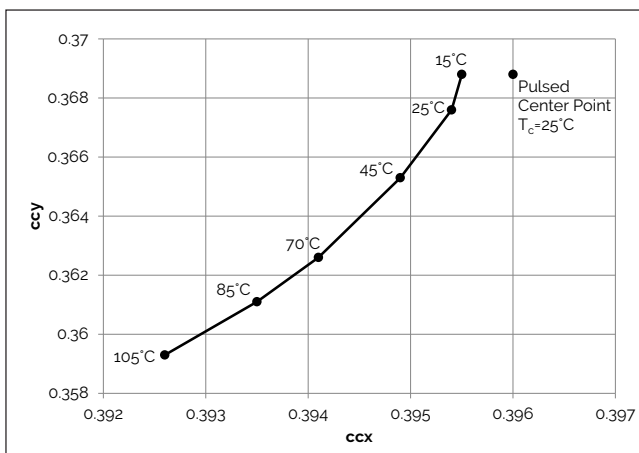
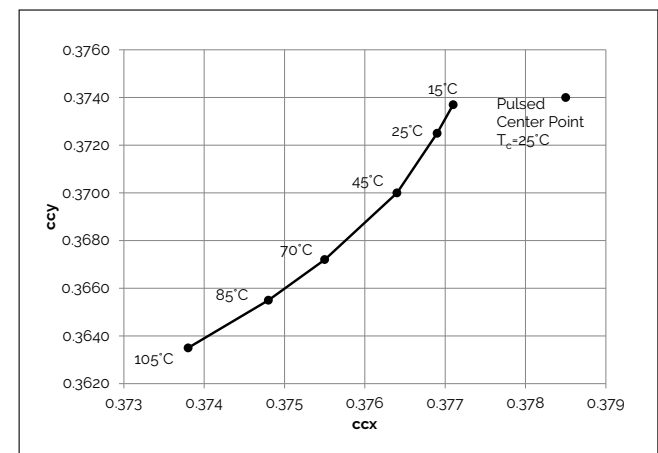

Figure 15: 4000K Class A Color Shift vs. Case Temperature¹



Note for Figures 10-15:

1. Measurements made under DC test conditions at the nominal drive current.
2. Typical color shift is shown with a tolerance of ± 0.002 .
3. Characteristics shown for Decor Series Showcase products, BXRC-30G200C-x-73

Typical Radiation Pattern

Figure 16: Typical Spatial Radiation Pattern

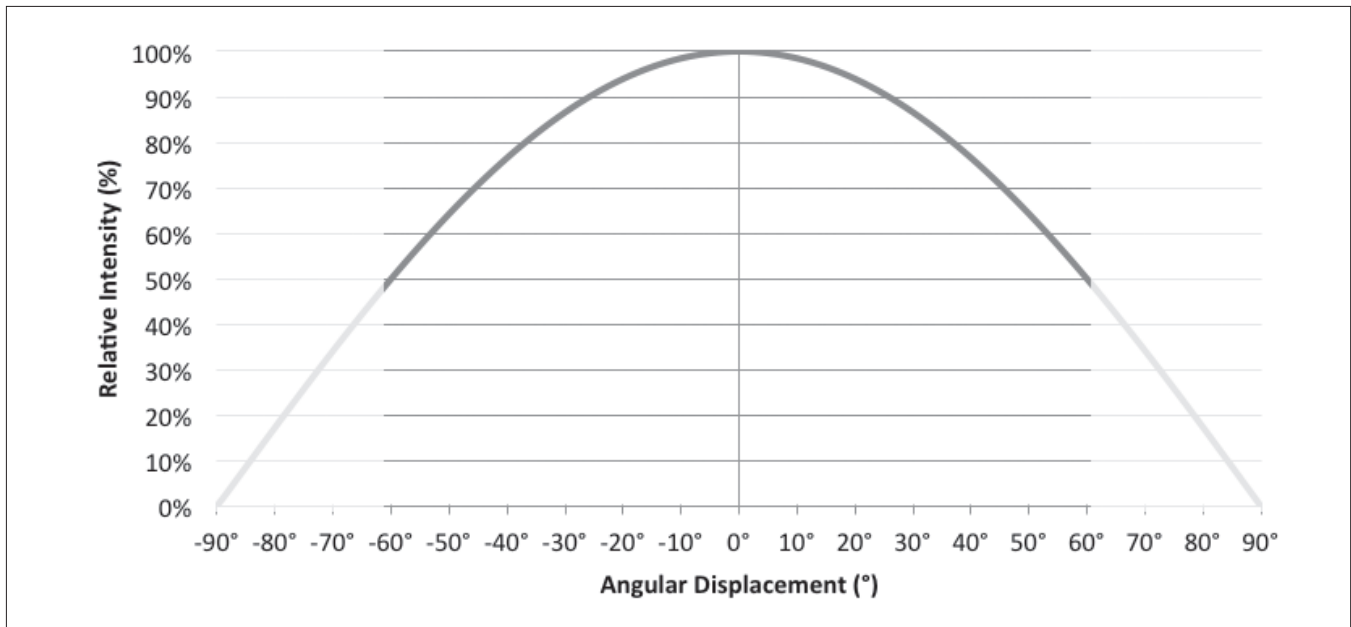

Note for Figure 16:

1. Typical viewing angle is 120°.
2. The viewing angle is defined as the off axis angle from the centerline where intensity is ½ of the peak value.

Figure 17: Typical Polar Radiation Pattern

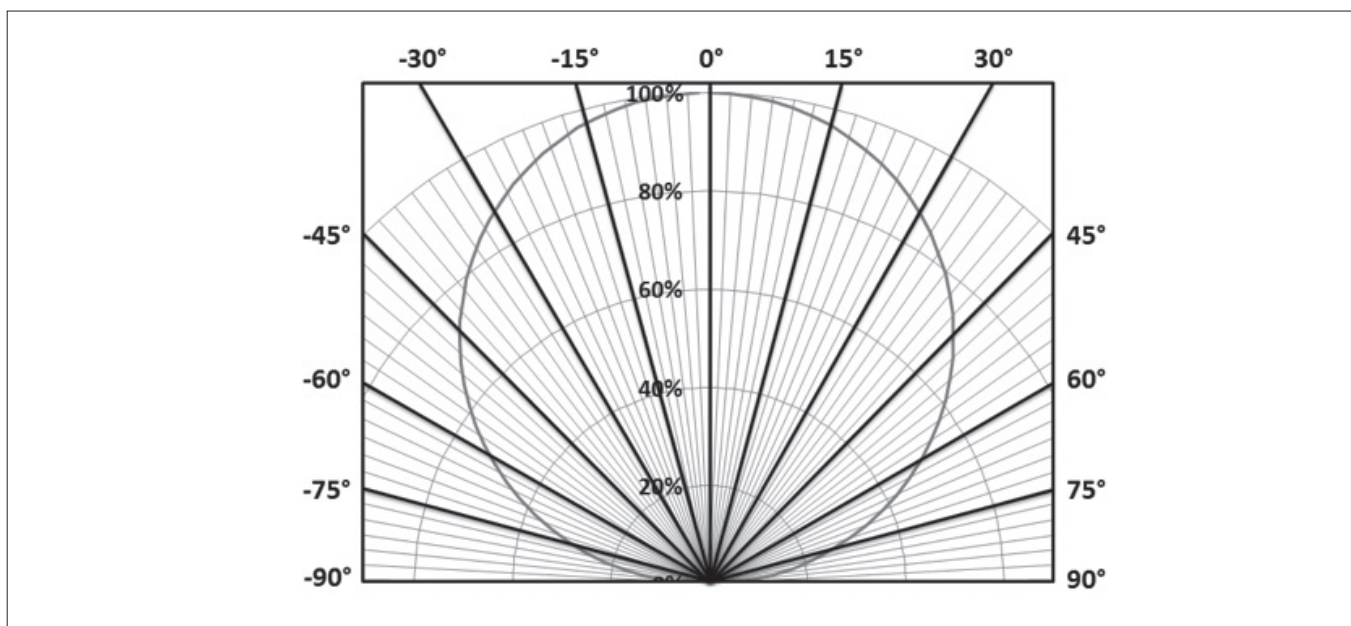

Typical Color Spectrum

Figure 18: Typical Color Spectrum

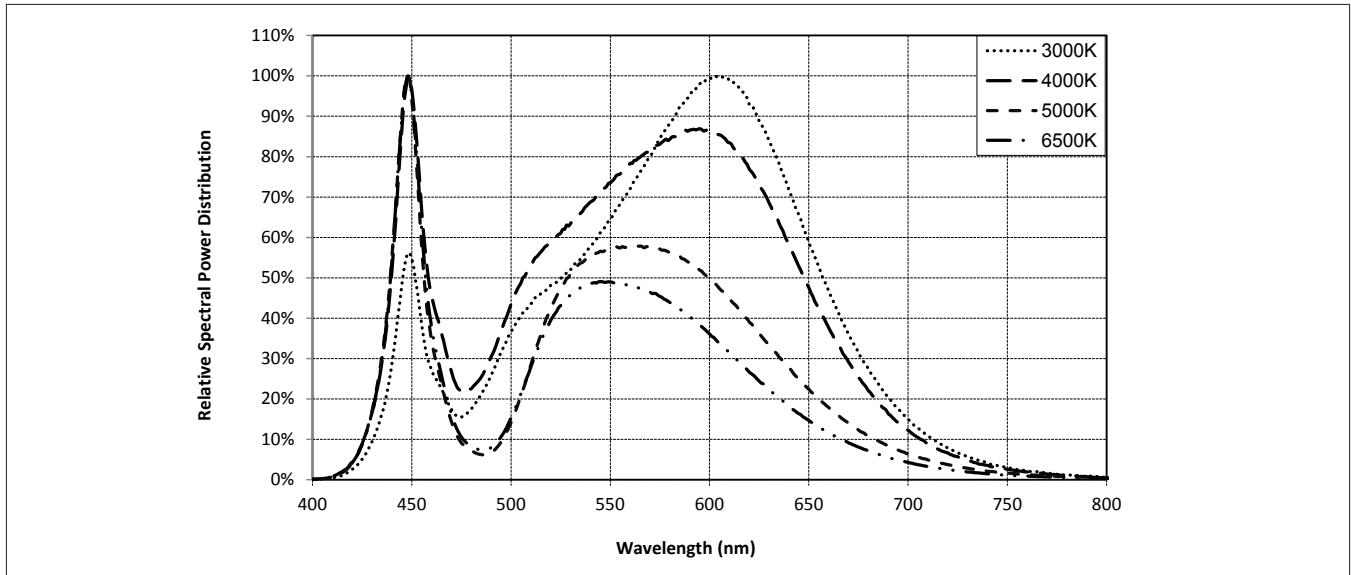

Note for Figure 18:

1. Color spectra measured at nominal current for $T_j = T_c = 25^\circ\text{C}$.
2. Color spectra shown is 3000K and 80 CRI.
3. Color spectra shown is 4000K and 80 CRI.
4. Color spectra shown is 5000K and 70 CRI.
4. Color spectra shown is 6500K and 70 CRI.

Figure 19: Typical Color Spectrum for Vero 13 with Décor Series

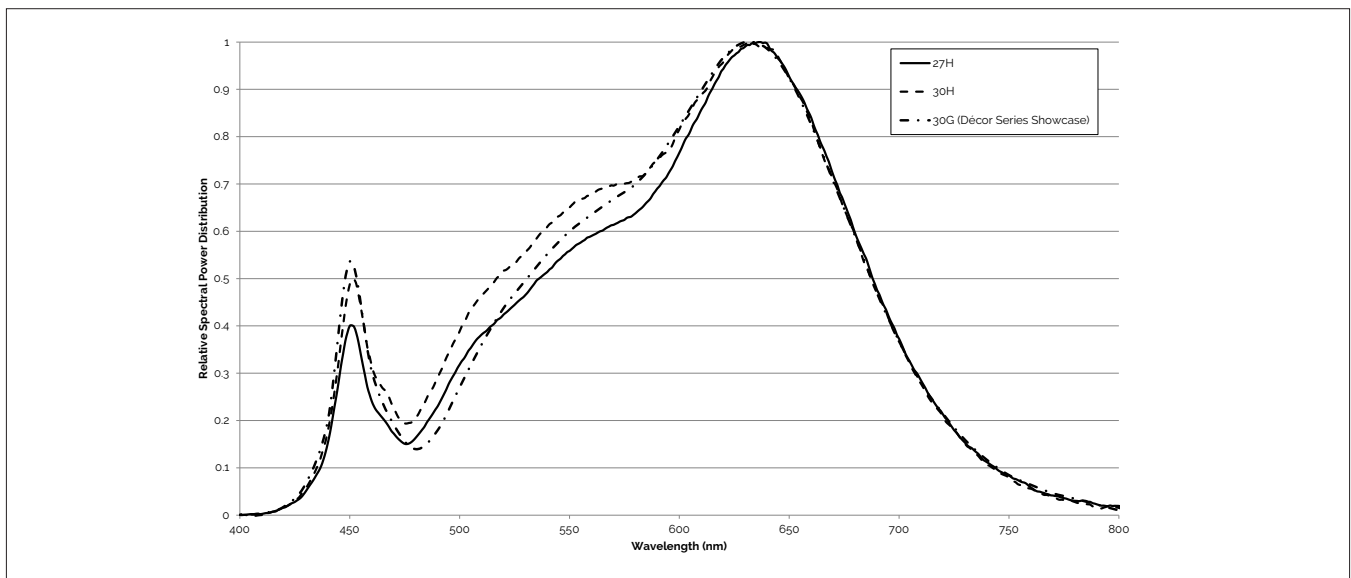

Note for Figure 19:

1. Color spectra measured at nominal current for $T_j = T_c = 25^\circ\text{C}$.

Mechanical Dimensions

Figure 20: Drawing for Vero 13 LED Array

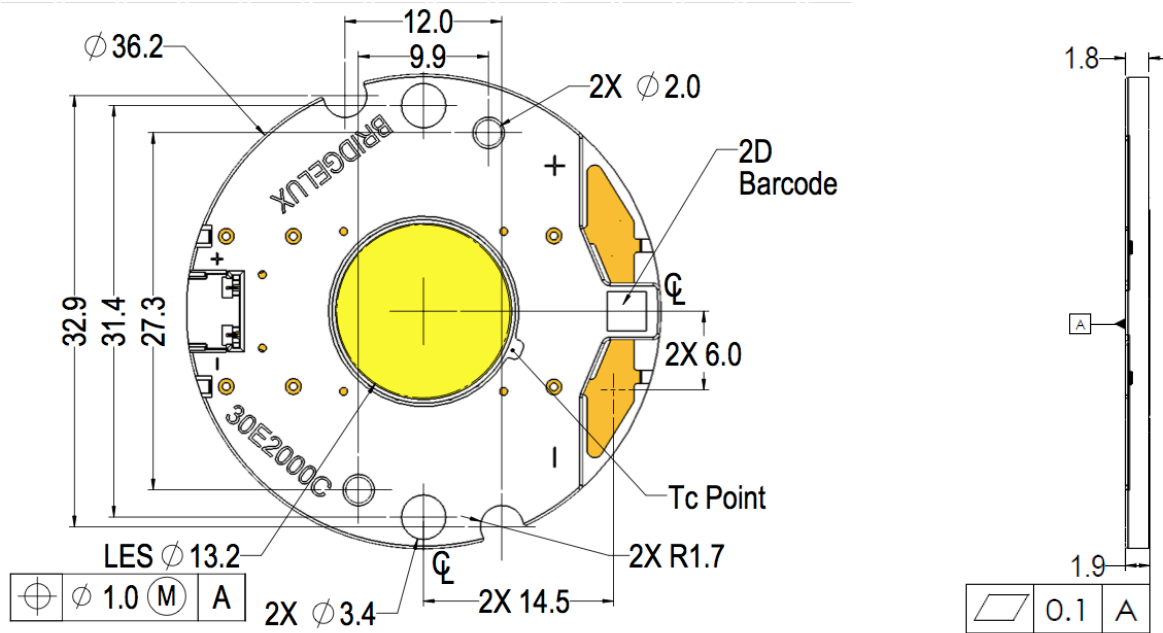

Notes for Figure 20:

1. Drawings are not to scale.
2. Drawing dimensions are in millimeters.
3. Unless otherwise specified, tolerances are $\pm 0.1\text{mm}$.
4. Mounting holes (2X) are for M2.5 screws.
5. Bridgelux recommends two tapped holes for mounting screws with $31.4 \pm 0.10\text{mm}$ center-to-center spacing.
6. Screws with flat shoulders (pan, dome, button, round, truss, mushroom) provide optimal torque control. Do NOT use flat, countersink, or raised head screws.
7. Solder pads and connector port are labeled "+" and "-" to denote positive and negative, respectively.
8. It is not necessary to provide electrical connections to both the solder pads and the connector port. Either set may be used depending on application specific design requirements.
9. Refer to Application Notes AN30 and AN31 for product handling, mounting and heat sink recommendations.
10. The optical center of the LED Array is nominally defined by the mechanical center of the array to a tolerance of $\pm 0.2\text{mm}$.
11. Bridgelux maintains a flatness of 0.10mm across the mounting surface of the array.

Color Binning Information

Figure 21: Warm and Neutral White Test Bins in xy Color Space

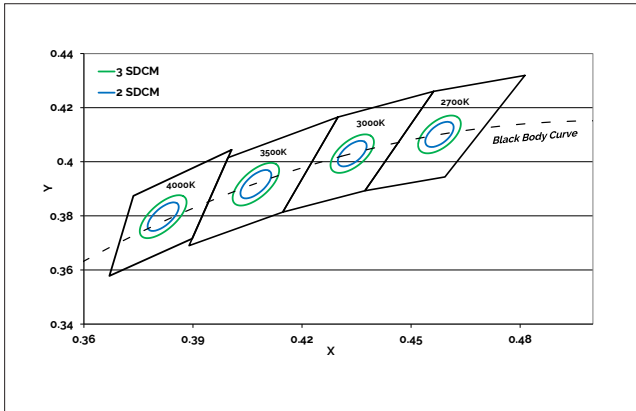

Note: Pulsed Test Conditions, $T_c = 25^\circ\text{C}$

Figure 22: Cool White Test Bins in xy Color Space

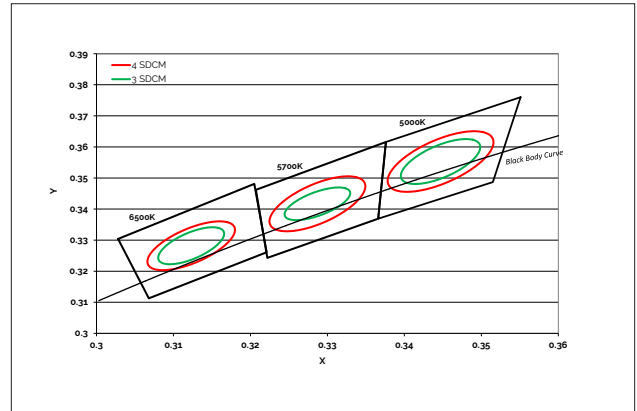

Note: Pulsed Test Conditions, $T_c = 25^\circ\text{C}$

Table 8: Warm and Neutral White xy Bin Coordinates and Associated Typical CCT

Bin Code	2700K	3000K ¹	3500K ¹	4000K ¹
ANSI Bin (for reference only)	(2580K - 2870K)	(2870K - 3220K)	(3220K - 3710K)	(3710K - 4260K)
73 (3 SDCM)	(2651K - 2794K)	(2968K - 3136K)	(3369K - 3586K)	(3851K - 4130K)
72 (2 SDCM)	(2674K - 2769K)	(2995K - 3107K)	(3404K - 3548K)	(3895K - 4081K)
Center Point (x,y)	(0.4578, 0.4101)	(0.4338, 0.403) (0.4465, 0.4024) ²	(0.4073, 0.3917)	(0.3818, 0.3797)

Note for Table 8:

- Color Binning information excludes Décor Series Class A products. Please contact your Bridgelux Sales Representative for more information.
- Center Point for Décor Series Showcase.

Table 9: Cool White xy Bin Coordinates and Associated Typical CCT (product is hot targeted to $T_c = 85^\circ\text{C}$)

Bin Code	5000K	5700K	6500K
ANSI Bin (for reference only)	(4745K - 5311K)	(5312K - 6022K)	(6022K - 7042K)
74 (4 SDCM)	(4801K - 5282K)	(5829K - 5481K)	(6270K - 6765K)
73 (3 SDCM)	(4835K - 5215K)	(5490K - 5820K)	(6250K - 6745K)
Center Point (x,y)	(0.3447, 0.3553)	(0.3287, 0.3417)	(0.3123, 0.3282)

Packaging and Labeling

Figure 23: Drawing for Vero 13 Packaging Tray

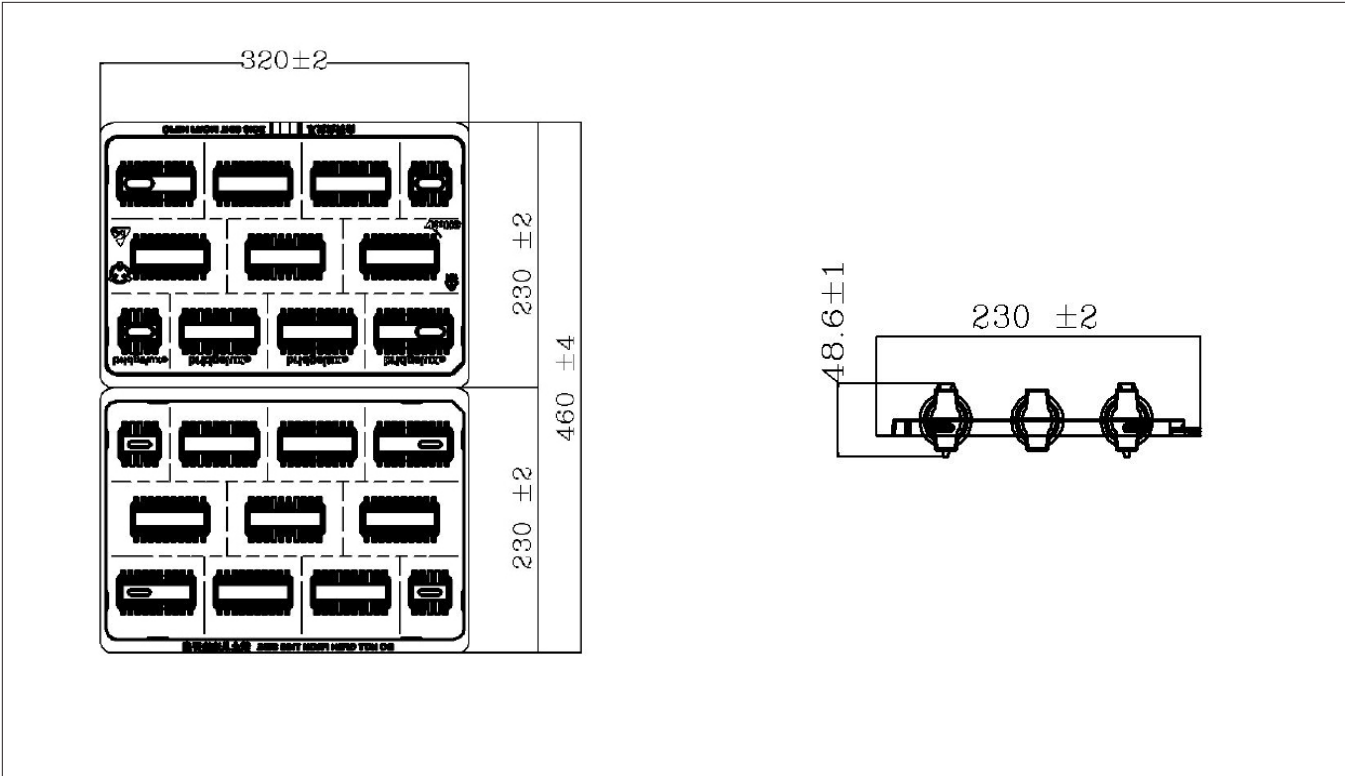

- Notes for Figure 23:
- 1. Dimensions are in millimeters.
 - 2. Drawings are not to scale.

Packaging and Labeling

Figure 24: Vero Series Packaging and Labeling

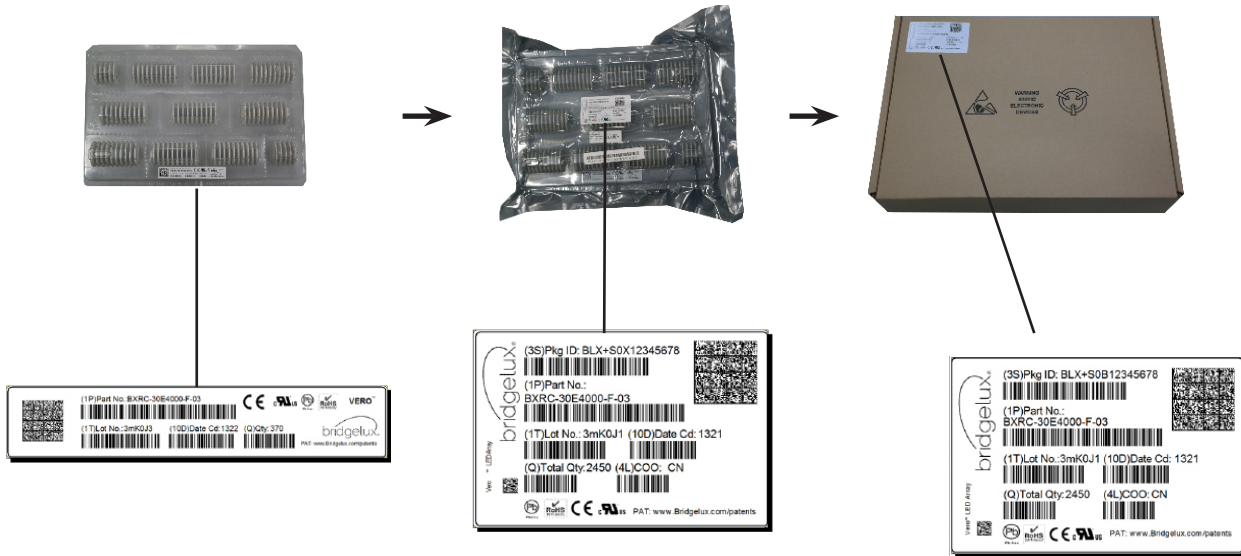

Notes for Figure 24:

1. Each tray holds 100 COBs.
2. Each tray is vacuum sealed in an anti-static bag and placed in its own box.
3. Each tray, bag and box is to be labeled as shown above.

Figure 25: Gen. 7 Product Labeling

Bridgelux COB arrays have laser markings on the back side of the substrate to help with product identification. In addition to the product identification markings, Bridgelux COB arrays also contain markings for internal Bridgelux manufacturing use only. The image below shows which markings are for customer use and which ones are for Bridgelux internal use only. The Bridgelux internal manufacturing markings are subject to change without notice, however these will not impact the form, function or performance of the COB array.

Customer Use- 2D Barcode
Scannable barcode provides product part number and other Bridgelux internal production information.

Customer Use- Product part number — **30E2000C 73 2F** — **Customer Use- V₁ Bin Code**
included to enable greater luminaire design flexibility. Refer to ANg2 for bin code definitions.

Design Resources

Application Notes

Bridgelux has developed a comprehensive set of application notes and design resources to assist customers in successfully designing with the Vero product family of LED array products. For all available application notes visit www.bridgelux.com.

Optical Source Models

Optical source models and ray set files are available for all Bridgelux products. For a list of available formats, visit www.bridgelux.com.

3D CAD Models

Three dimensional CAD models depicting the product outline of all Bridgelux Vero LED arrays are available in both IGS and STEP formats. Please contact your Bridgelux sales representative for assistance.

LM80

LM80 testing has been completed and the LM80 report is now available. Please contact your Bridgelux sales representative for LM-80 report.

Precautions

CAUTION: CHEMICAL EXPOSURE HAZARD

Exposure to some chemicals commonly used in luminaire manufacturing and assembly can cause damage to the LED array. Please consult Bridgelux Application Note AN31 for additional information.

CAUTION: RISK OF BURN

Do not touch the Vero LED array during operation. Allow the array to cool for a sufficient period of time before handling. The Vero LED array may reach elevated temperatures such that could burn skin when touched.

CAUTION

CONTACT WITH LIGHT EMITTING SURFACE (LES)

Avoid any contact with the LES. Do not touch the LES of the LED array or apply stress to the LES (yellow phosphor resin area). Contact may cause damage to the LED array.

Optics and reflectors must not be mounted in contact with the LES (yellow phosphor resin area). Optical devices may be mounted on the top surface of the plastic housing of the Vero LED array. Use the mechanical features of the LED array housing, edges and/or mounting holes to locate and secure optical devices as needed.

Disclaimers

MINOR PRODUCT CHANGE POLICY

The rigorous qualification testing on products offered by Bridgelux provides performance assurance. Slight cosmetic changes that do not affect form, fit, or function may occur as Bridgelux continues product optimization.

STANDARD TEST CONDITIONS

Unless otherwise stated, array testing is performed at the nominal drive current.

About Bridgelux: Bridging Light and Life™

At Bridgelux, we help companies, industries and people experience the power and possibility of light. Since 2002, we've designed LED solutions that are high performing, energy efficient, cost effective and easy to integrate. Our focus is on light's impact on human behavior, delivering products that create better environments, experiences and returns—both experiential and financial. And our patented technology drives new platforms for commercial and industrial luminaires.

For more information about the company, please visit
bridgelux.com
twitter.com/Bridgelux
facebook.com/Bridgelux
youtube.com/user/Bridgelux
linkedin.com/company/bridgelux-inc-_2
WeChat ID: BridgeluxInChina



46430 Fremont Boulevard
Fremont, CA 94538 U.S.A.
Tel (925) 583-8400
www.bridgelux.com

© 2016-2018 Bridgelux, Inc. All rights reserved 2018. Product specifications are subject to change without notice. Bridgelux, the Bridgelux stylized logo design, Vero, V Series and V Series HD are registered trademarks, and Decor Series is a trademark of Bridgelux, Inc. All other trademarks are the property of their respective owners.

Bridgelux Gen 7 Vero 13 Array Series Product Data Sheet DSg1 Rev. N (10/2018)